



NEXUS

DUAL

10W

USER MANUAL



Underground Magnetics

simple. powerful. affordable.

1. About this Guide

Congratulations on your purchase of an Underground Magnetics Utility Locating System!

Please read this manual in its entirety before attempting to use the Utility Locating System, for further information about Underground Magnetics locating products please visit umaghdd.com

This manual applies to all Utility Locating System equipment:

- ❖ UM Dual Receiver, a handheld portable, ergonomic, and lightweight design.
- ❖ UM 10w Transmitter, a powerful 10W multi frequency signal transmitter.
- ❖ Universal Signal Clamp, for use with both the Receiver and Transmitter
- ❖ Li-ion Battery Chargers, for use with both the Receiver and Transmitter.
- ❖ Alkaline Battery Trays, for use where preferred.
- ❖ Insulated Connection Leads, for safe direct connection to utility lines or tracer wires.
- ❖ Ground Stake and Cable Reel, for remote ground connection.
- ❖ Equipment Bag, weatherproof, secure, and durable.

CAUTION

This guide provides instructions on the use of the UM Dual Receiver and 10w Transmitter. It should be read before operating the Receiver and Transmitter. It contains important safety information and operating guidelines.

1.1 Symbols

The symbols used in this manual have the following meanings:

ATTENTION

This alert indicates attention to a particular feature, setting, or consideration including recommended uses.

CAUTION

This alert indicates a hazardous situation that could result in minor or moderate injury if not avoided.

WARNING

This alert indicates a hazardous situation that could result in major injury or death if not avoided.

TIPS

Tips and Tricks intended to inform users of information that is good to know.

2. Contents

1. About this Guide	2
1.1 Symbols	2
3. Compliance	5
3.1 United States.....	5
3.2 Canada.....	6
3.3 Europe.....	6
4. Service and Support.....	7
4.1 Training.....	7
4.2 Service & Support.....	7
5. Batteries.....	8
5.1 Charging Li-ion.....	8
5.2 Alkaline Batteries	8
6. UM Dual Receiver	9
6.1 Quick Start	9
6.2 User Interface	10
6.3 Key Functions	11
6.4 User Menu.....	12
6.5 Operating Modes.....	14
6.5.1 Single.....	14
6.5.2 Twin	14
6.5.3 Null	14
6.5.4 Sweep (Omni Directional)	15
6.5.5 Twin Sweep (Omni Directional)	15
6.6 Operating Frequency	16
6.6.1 Active Frequencies	16
6.6.2 Grouped Power.....	16
6.6.3 Single Power	16
6.6.4 Radio.....	16
6.7 Clamp Accessory	16
6.8 Receiver Features	17
6.8.1 One Touch Gain	17
6.8.2 Auto Depth / Current.....	17
6.8.3 Frequency Analyzer	17
6.8.4 Operating Frequency	18
6.8.5 Warnings and Alerts	18
6.8.6 Data Logger.....	18
7. UM 10w Transmitter	19
7.1 Quick Start	19
7.2 User Interface	20
7.3 Key Functions	21
7.4 User Menu.....	22
7.5 Operating Modes.....	23
7.5.1 Direct Connection	23
7.5.2 Signal Clamp	23
7.5.3 Induction (3.14kHz and up).....	23
7.6 Output Power	24
7.7 Operating Frequency	24
7.7.1 Standard Frequencies.....	24
7.8 Warnings and Alerts	25
7.8.1 Direct Connection	25
7.8.2 Signal Clamp	25
8. Accessories.....	26
9. Using the Utility Locating System.....	27
9.1 Locating Process	28
9.1.1 Information.....	28

9.1.2	Inspection	28
9.1.3	Locating	28
9.1.4	Best practice	28
9.2	Utility Locating	29
9.2.1	Depth and Signal Current Reading.....	29
9.3	Active Locating	30
9.3.1	Direct Connection.....	31
9.3.2	Transmitter Clamp.....	32
9.3.3	Induction	33
9.3.4	Sonde Locating.....	34
9.4	Passive Locating	35
9.5	Passive Detection.....	36
9.5.1	Perimeter Search.....	36
9.5.2	Large Area Search	36
9.5.3	Area Avoidance	37
9.5.4	Two Man Area Sweep	37
9.6	Receiver accessories	38
9.6.1	Receiver Clamp	38
9.6.2	Data Logging	38
10.	Locating Techniques	39
10.1	Site observations	39
10.2	Locating	39
10.3	Best Practices	42
10.4	Improving Locate Quality.....	44
10.5	Detection- Avoidance	45
10.5.1	Perimeter Sweep	45
10.5.2	Area Search.....	45
10.6	Sonde Locating	46
10.6.1	Initial Locate - Unknown Sonde Position	46
10.6.2	Pinpointing	47
10.6.3	Null Points.....	48
11.	Technical Data Table.....	49
11.1	Receiver Specifications.....	49
11.2	Transmitter Specifications	50
11.3	System Specifications.....	50
12.	Safety Directions	51
12.1	Intended Use	51
12.2	Adverse Use	51
12.3	Limits of Use	51
12.4	Responsibilities.....	52
12.5	Hazards of Use.....	52
12.6	Worksite Safety.....	52
12.7	Batteries and Environmental Safety.....	53
12.8	Equipment Safety	53
13.	Appendix 1 Best Practice Training Instruction	54

3. Compliance

3.1 United States

This device complies with Part 15 of the FCC Rules. Operation is subject to the following two conditions:

- ❖ This device may not cause harmful interference, and
- ❖ This device must accept any interference received, including interference that may cause undesired operation.
- ❖ Changes or modifications not expressly approved by Underground Magnetics Inc. will void the user's authority to operate equipment.

Note: This product has been tested and found to comply with the limits for a Class B digital device, pursuant to Part 15 of the FCC Rules. These limits are designed to provide reasonable protection against harmful interference in a residential installation. This product generates, uses, and can radiate radio frequency energy, and if not installed and used in accordance with the instructions, may cause harmful interference to radio communications. However, there is no guarantee that interference will not occur in a particular installation. If this product does cause harmful interference to radio or television reception, which can be determined by turning the equipment off and on, the user is encouraged to try to correct the interference by one or more of the following measures:

- ❖ Reorient or relocate the receiving antenna.
- ❖ Increase the separation between the equipment and the Receiver.
- ❖ Connect the equipment into an outlet on a circuit different from that to which the Receiver is connected.
- ❖ Consult the dealer or an experienced radio/TV technician for help.

⚠ WARNING

Cancer, birth defects, and other reproductive harm. www.P65warnings.ca.gov.

Contains FCC ID: XPYNINAB4

FCC Part 15 Class B

2014/30/EU EMC Directive

2011/65/EU RoHS Directive

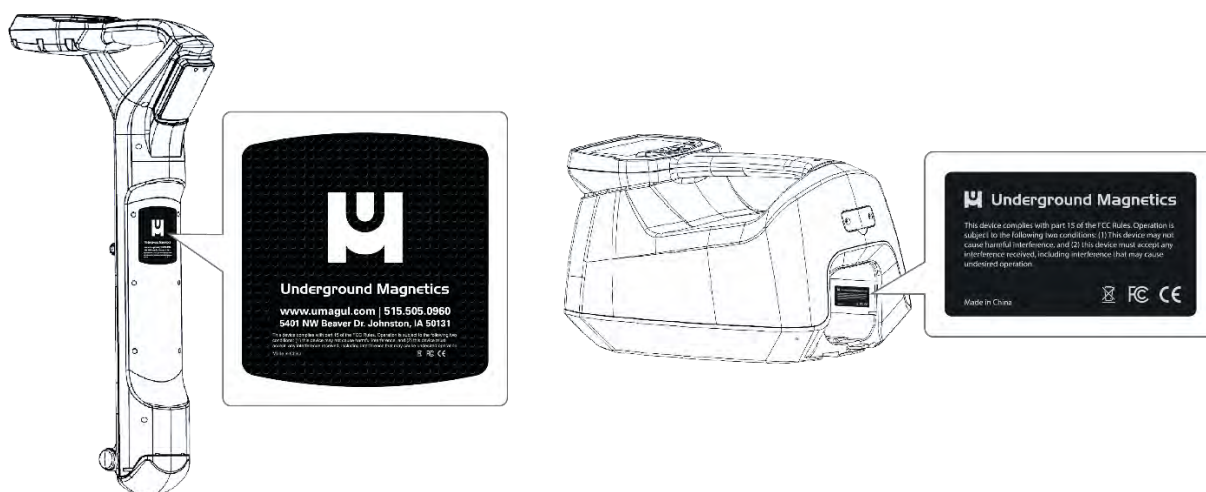

3.2 Canada

CAN ICES-003

This Class A digital device complies with Industry Canada license-exempt RSS standard(s). Operation is subject to the following conditions:

- ❖ This device may not cause interference.
- ❖ This device must accept any interference, including interference that may cause undesired operation of the device.

Contains IC: 895A-NINAB4

Cet appareil numérique de la classe A est conforme à la norme NMB-003 du Canada

3.3 Europe

Underground Magnetics, Inc confirms that the Utility Location System is compliant with the relevant provision of Council Directives: 2014/30/EU EMC Directive and 2011/65/EU RoHS Directive.

Receiver:

EN 55032:2015+A1:2020, EN 55035:2017+A11:2020, EN 61000-3-2:2019+A1:2021, EN 61000-3-3:2013+A2:2021, EN 55011:2016+A2:2021, EN 61010-1:2010+A1:2019, EN 300 328 V2.2.2, EN 301 489-1, EN 301 489-17, EN 62311:2020

Transmitter:

EN 61000-4-2, EN 61000-4-3, EN 61000-4-8, EN 61326-1 : 2013, EN 61010-1 : 2010/ A1:2019

CAUTION

Electromagnetic radiation can cause disturbances to other equipment.

Precautions: The product meets strict EMC regulations and Standards; Underground Magnetics cannot completely exclude the possibility that other equipment may be disturbed.

Changes or modifications not expressly approved by Underground Magnetics for compliance could void the user's authority to operate the equipment.

Precautions: Do not modify the products or use non-approved accessories

If the product is operated with connecting cables attached at only one of their two ends, the permitted level of electromagnetic radiation may be exceeded and correct functioning of the product impaired.

Precautions: When the product is in use connecting cables must be connected at both ends.

Radiated electromagnetic fields can cause disturbances in other equipment, installations, or medical devices, for example mobile telephones, two-way radio communication equipment, pacemakers, or hearing aids.

Precautions: Underground Magnetics cannot completely exclude the possibility that other equipment may be disturbed, or that humans or animals may be affected

4. Service and Support

Always quote your Receiver and Transmitter model, serial number and software version when requesting product support. They can be found as follows:

- ❖ Model and serial number are found on the product label.
- ❖ Software revision and serial numbers are found in the SETTINGS menu and Sub menu System Information.

ATTENTION

Erroneous results due to equipment damage, abnormal or misuse.

Precautions: Periodic test for normal operation and results on other known utilities.

Do not use if the Product is faulty. Service check by an authorized service center.

4.1 Training

All users should use this User's Manual to familiarize themselves with the use of the Product before use, understand the basis of operation and become familiar with applications best practices applicable to the use of the Utility Receiver System.

TIPS

Many companies operate their own training program of user training or use 3rd party training services partners. Always ensure any training provider is familiar with the Underground Magnetics Utility Locating System.

Underground Magnetics offer an individualized on-site certificated user training program, contact Underground Magnetics Service Support or your dealer for full information.

4.2 Service & Support



Underground Magnetics
5401 NW Beaver Dr.
Johnston Iowa 50131, USA

Monday - Friday 8:00 AM – 5:00 PM
support@umaghdd.com
(515) 505-0960

5. Batteries

The Utility Locating System is supplied with Lithium-ion sealed rechargeable battery packs, 2 for the Receiver and 2 for the Transmitter. These batteries provide extended operation at low temperatures and convenience during extended all day field use. Significantly improved operating time at low temperatures. Alkaline battery trays are also supplied for user preference or emergency use.

CAUTION

If battery terminals come into contact with jewelry, keys, or other metals, a short circuit may occur with potential of overheating, cause injury or fire.

Precautions: Do not transport batteries in pockets. Do not allow the battery terminals to come into contact with metallic objects.

Risk of electrical shock when removing the Transmitter battery pack.

Precautions: Before removing the battery pack switch off the Transmitter and remove any cable set or accessory from the connection socket.

5.1 Charging Li-ion

The Battery packs are designed for all day operation and where the spare Receiver pack can be swapped if needed. Packs can be charged with the supplied AC mains charger for convenience.

Charging status is indicated by a red charging light and charging is complete when the light is green.

Approximate Charge Time:

Receiver: 2 hours

Transmitter: 4 hours

CAUTION

Unapproved battery chargers may cause damage to the product, charger, or rechargeable battery. In extreme cases, they cause a fire.

Precautions: Only use an Underground Magnetics specified charger. If in doubt call your service support provider

Batteries may be damaged if stored for extended periods without use.

Precautions: Ensure battery is at least partially charged or removed for storage. If products are not being used for an extended period of time, you charge batteries at least once a month.

5.2 Alkaline Batteries

Alkaline batteries may be preferred when working in remote areas where battery recharging is difficult or to enable further operation when both rechargeable battery packs are discharged.

Receiver: 6x AA (LR6)

Transmitter: 8x D (LR20)

TIPS

Always replace the batteries with the same type and never mix old and new batteries.

For best results, particularly at low temperatures, always use premium brand types.

Ensure that the batteries are inserted the correct way.

Always dispose of batteries responsibly

6. UM Dual Receiver



6.1 Quick Start

1. Press and hold the **POWER** key to turn on the Receiver.
2. Press the **FREQUENCY** key to change the operating frequency.
3. Gain **UP** or **DOWN**
4. Press the **SETTINGS** key to enter the menu.
5. Press the **SETTINGS** key to enter the menu.
 - Press **UP** and **DOWN** to navigate.
 - **FREQUENCY** to change a setting or enter a submenu.
 - Press **MODE** to exit.

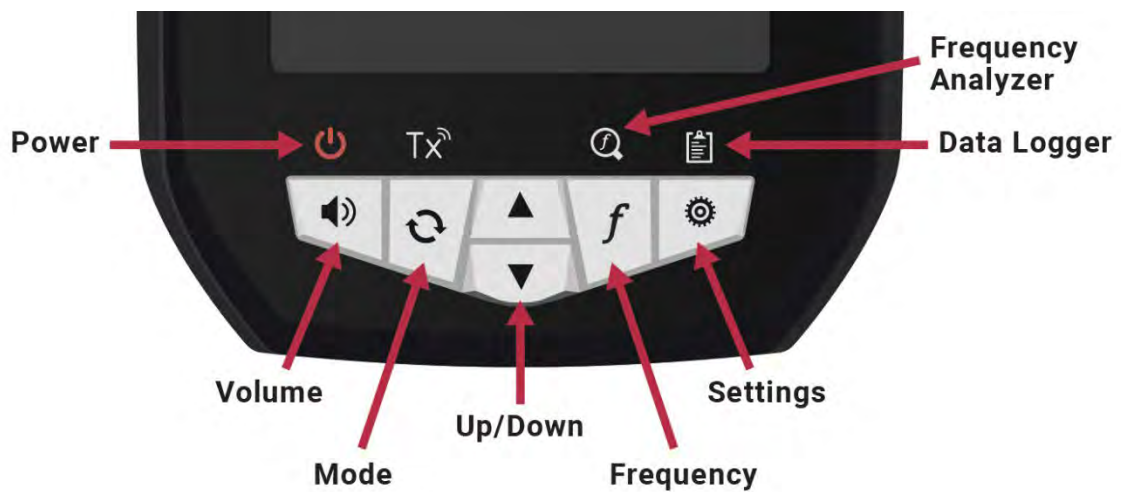

Each key can be operated with either a short or long press.

6.2 User Interface

There are two main contexts for the Transmitter: Locate Screens and Menu Screens.



Screen Information

Mode	Select Trace Modes Twin Peak or Single Peak, Sweep Modes, Twin Sweep (Omni Directional) or Single Sweep (Omni Directional)
Signal Strength & Bar graph	Detected signal level
Gain	Receiver gain level
Guidance Arrow, NULL Locate	Graphics pointing the user toward the target conductor
Frequency	Operating frequency
Depth & Current Estimates	Estimated depth and the Transmitter signal current of the target conductor
Volume	Audio volume level
Battery	Battery level
Compass	Indicates orientation of the target conductor

6.3 Key Functions

The keys can have distinct functions depending on context.







Short Press

- ❖ 0.5 seconds or less
- ❖ The key function will be executed on release of the key.
- ❖ Functions are printed directly on the keys.







Long Press

- ❖ 0.5 seconds or longer
- ❖ The key function will be executed when the key has been held for 0.5 seconds.
- ❖ Continuing to hold the key has no effect.
- ❖ Functions are printed above the keys.





Main Screen Key Functions (Long Press)

	POWER	Press or press and hold to power OFF
	TRANSMITTER CONTROL	<i>N/A on this model</i>
	FREQUENCY ANALYZER	Determines best frequency options based on environmental interference.
	DATA LOGGER	Send a log to connected BLE device Force display of estimated depth (<i>Future Feature Upgrade</i>)
	UP	Increase gain repeatedly
	DOWN	Decrease gain repeatedly

Main Screen Key Functions (Short Press)

	VOLUME	Change the audio volume. (3 levels + mute)
	MODE	Change the Mode of the Receiver. There are 5 Modes that correspond to antenna signals used.
	UP	Increase gain
	DOWN	Decrease gain
	FREQUENCY	Change the operating frequency
	SETTINGS	Opens the settings

Menu Key Press Functions (Short Press)

	VOLUME	Exits to the locate screen
	MODE	Exit the menu or submenu
	UP	Move the selection up
	DOWN	Move the selection down
	FREQUENCY	Change a setting or enter a submenu

6.4 User Menu

(Actual Menu options may vary)

» indicates that there is a submenu
FREQUENCY key will enter a submenu if present
FREQUENCY key changes setting otherwise.



System Information

Information about the Receiver

Metrics

Usage statistics

METRICS			
Run Time	2:50:54	Frequencies	
		12.1kHz	50%
		60Hz PWR	16%
		POWER 60	7%
		Modes	
		Twin	64%
		Twin Sweep	18%
		Sweep	10%

Guidance Arrow, NULL Locate
 Indicates the location of the line relative to the Receiver

- ❖ Off
- ❖ Style 1: Directional Arrow
- ❖ Style 2: Proportional Arrow

Depth & Current
 Selects how depth and current estimates are displayed

- ❖ Auto: Displayed when conditions are met
- ❖ On: Displayed when 0 > depth ≥ 6m (19'8")

Audio
 Change the audio modulation and waveform.

- ❖ Audio Modulation: FM (Pitch) or AM (Volume)
- ❖ Audio Sound: Rough or Smooth



Backlight
 Changes the backlight intensity:
 (Higher intensity will reduce battery life)

- ❖ LOW
- ❖ MEDIUM
- ❖ HIGH

Modes

Selects Modes to choose from when user presses **MODE** key.

- ❖ Single
- ❖ Twin
- ❖ Null
- ❖ Sweep
- ❖ Twin Sweep (Omni Directional)

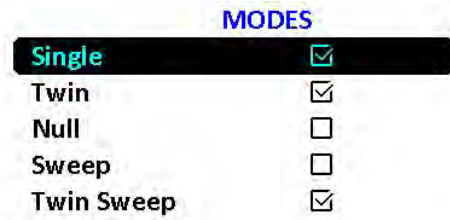

Frequencies

Selects which frequencies to choose from when the user presses the **FREQUENCY** key.

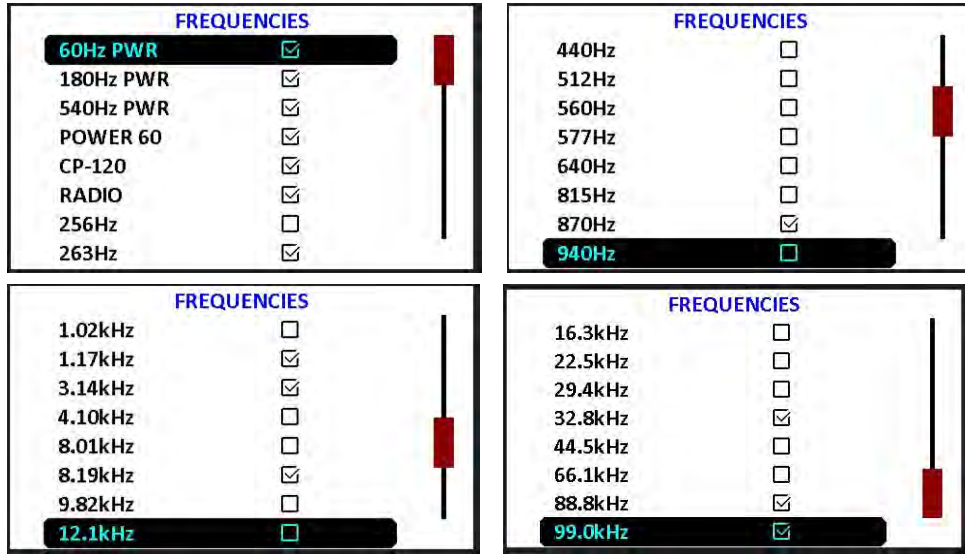

Units

Selects the units for the depth estimate.

- ❖ IMPERIAL
- ❖ METRIC

Auto Shutdown

Selects the time before the Receiver shuts down if no keys are pressed.

- ❖ NEVER
- ❖ 5 minutes
- ❖ 10 minutes
- ❖ 30 minutes

Regulatory Info

Information on RF modules in the Receiver
Radio module FCC ID

REGULATORY INFO

Contains
FCC ID: XPYNINAB4 IC: 8595A-NINAB4

TIPS

Complete set up preferences before first use.
Customize active Modes and Frequencies for simplicity and convenience when switching Modes.

6.5 Operating Modes

The Dual Receiver has antennas that can be used for different responses (Modes) and Locate styles responding to the signals radiating from buried utilities.

6.5.1 Single

	<p>Select Mode</p>	<p>Mode Icon</p>	<p>Compass</p>
	<p>This provides a broad Peak maximum response.</p> <div style="border: 2px solid blue; padding: 5px;"> <p>TIPS Ideal for an area wide Detection. Where the position of the utility is unknown and very deep. For improved pinpointing Twin Mode should be used.</p> </div>		





6.5.2 Twin

	<p>Select Mode</p>	<p>Mode Icon</p>	<p>Compass</p>
	<p>This provides a sharp Peak or maximum response.</p> <div style="border: 2px solid blue; padding: 5px;"> <p>TIPS This is the most accurate operating Mode. Improved Locate pinpointing and accuracy in congested areas. The peak reading is displayed for a few seconds to enable a 2-step sweep and Locate operation quickly.</p> </div>		



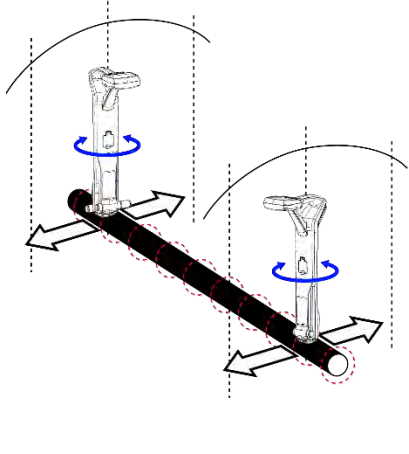

6.5.3 Null

	<p>Select Mode</p>	<p>Mode Icon</p>	<p>Compass</p>
	<p>This provides a Null or minimum response.</p> <div style="border: 2px solid blue; padding: 5px;"> <p>TIPS Some users prefer this Mode. It works best in non-congested areas but becomes less accurate in congested areas. A fast way to trace a utility without precision Locating</p> </div>		

6.5.4 Sweep (Omni Directional)

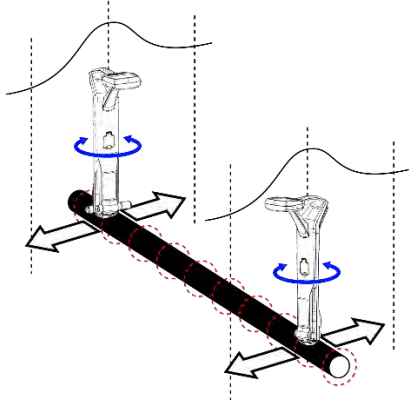
	 Select Mode	 Mode Icon	 Compass
Multiple antennas provide a Peak proximity response in any direction.			
<div style="border: 2px solid blue; padding: 5px;"> <p> TIPS Ideal for an area wide Sweep Detection. Where the direction of the utility is unknown and very deep.</p> </div>			

6.5.5 Twin Sweep (Omni Directional)

	 Select Mode	 Mode Icon	 Compass
Multiple antennas provide a sharper Peak proximity response in any direction.			
<div style="border: 2px solid blue; padding: 5px;"> <p> TIPS Improved Locate pinpointing</p> </div>			

6.6 Operating Frequency

6.6.1 Active Frequencies

- Shown as xxxHz or x.xxkHz, where xxx is the target frequency.
- Factory Standard Frequencies: 256Hz, 263Hz, 440Hz, 512Hz, 560Hz, 577Hz, 640Hz, 815Hz, 870Hz, 940Hz, 1.02kHz, 1.17kHz, 3.14kHz, 4.09kHz, 8.01kHz, 8.19kHz, 9.82kHz, 29.4kHz, 32.8kHz, 44.5kHz, 66.0kHz, 88.8kHz. And 99.9kHz.

6.6.2 Grouped Power

- Shown as Power 60 (Power 50 for 50Hz power grid)
- The Receiver measures the signal at the target frequency and relevant odd power harmonics.
- Audio output reflects the spectral content of the received signal.
- Provides detection of any grade of Power cable

6.6.3 Single Power

- Shown as PWR xx, where xx is the target frequency.
- The Receiver measures the signal at the target frequency.
- Factory Standard Single Power Frequencies: 60Hz, 180Hz, and 540Hz. (50Hz, 150Hz, and 450Hz for 50Hz power grid)
- Can improve detection of single phase and 3 phase LV, MV and HV power grids.

6.6.4 Radio

- ❖ Shown as Radio
- ❖ The Receiver measures any communications signals in a frequency band from 12kHz to 25kHz.
- ❖ Audio output reflects the spectral content of the received signal.

6.7 Clamp Accessory

The Clamp Accessory can be used with the Receiver to help identify a Utility by measuring the Transmitter signal present . Connect the Clamp to the Receiver's accessory port and clamp around the Utility.

6.8 Receiver Features

6.8.1 One Touch Gain

One Touch Gain will attempt to set Receiver signal to approximately 50%. (Hold the Receiver still)

- ❖ If signal ≤ 20 , **UP** key will set signal to 50.
- ❖ If signal ≥ 80 , **DOWN** key will set signal to 50.

TIPS

The signal strength reduces with increased utility depth and moving further away from the Transmitter. Sudden changes of Signal Strength can indicate a Tee joint, cable ground sheath fault, or change in depth.

6.8.2 Auto Depth / Current

There are two depth and current display settings:

- ❖ **ON** – Displays depth and current when depth is positive and less than 19' 8" (6m).
- ❖ **Auto** – Displays depth and current when compass angle is in range, Guidance Arrow, NULL Locate are centered, and the Receiver is being held still in addition to the ON conditions above.

TIPS

Ideal for faster multiple Locates. Can quickly help identify a notable change in underground conditions, a change in depth, a utility spur, Tee or unexplained reduction in signal current.

6.8.3 Frequency Analyzer

1. With Transmitter OFF and Receiver held still, Long Press the **FREQUENCY** button.

The results indicate electrical interference levels at all active Frequencies and live measurement of the selected frequency.

Results are sorted by lowest noise. Results are color coded by noise level: Green for low, Yellow for average, and Red for high noise level.

2. Use the **UP** and **DOWN** key to select a different frequency.



The results enable the user to select the best Transmitter signal frequency, with low interference, for the best Locate quality and increased tracing distance.

3. Press the **FREQUENCY** key to exit the Analyzer and use the selected frequency or press the **MODE** key to exit without changing the frequency.

FREQUENCIES		
870Hz		0 ▶ 25
1.17kHz		0
263Hz		11
8.19kHz		36
99.0kHz		83
88.8kHz		178
3.14kHz		179
32.8kHz		206

TIPS

Lower signal interference improves the Locate quality and Trace further from the Transmitter.

-  Always try to use a frequency with low noise.
-  Use the live interference measurement feature to check interference at multiple places to help decide the best selection.

6.8.4 Operating Frequency

The operating frequency can be adjusted using the **FREQUENCY** key to scroll through all the Frequencies enabled in the User Menu.

TIPS

Customize the setting to user preferences or ideally match for Locating specific utility types.
Faster Mode changes between custom settings such as Connected (low frequency) or Induction (High Frequency) operation.

6.8.5 Warnings and Alerts

If the electronic circuits are overloaded and out of normal operating range, there is the potential for reduced performance. Signal strength indication will flash **RED**.

6.8.6 Data Logger

The Receiver features built-in data logging capability. With 4GB of internal storage, it can store over 16 million records. *(Future Feature Upgrade)*

7. UM 10w Transmitter

The Transmitter is a rugged portable transmitter designed for all field conditions. The Transmitter is used to apply a unique tracing signal to an individual utility line or to assist in detection of multiple utilities in a site area. A range of operating frequencies from 256Hz to 200kHz are available to best suit the widest range of locating applications and operating environments.

When using supplied Connection Leads or Signal Clamp Accessories the tracing signal can be directly applied to isolated or in use utilities for most common applications. An internal Induction antenna can be used to induce the tracing signal to an inaccessible utility or be used to help detect and Locate utilities of unknown presence or position.

The Transmitter is powered by a long-lasting Li-ion battery to provide extended all day operation, even in low ambient temperatures and when operated at the highest output power level. An Alkaline battery tray is provided for emergency use or preferred operation.



7.1 Quick Start

6. Press and hold the **POWER** key to turn ON the Transmitter.
7. Press the **FREQUENCY** key to change the operating frequency.
8. Press the **UP** or **DOWN** keys to change the output power level.
9. Press the **SETTINGS** key to enter the menu.
 - Press **UP** and **DOWN** to navigate.
 - Press **FREQUENCY** to change a setting or enter a sub menu.
 - Press **MODE** to exit.

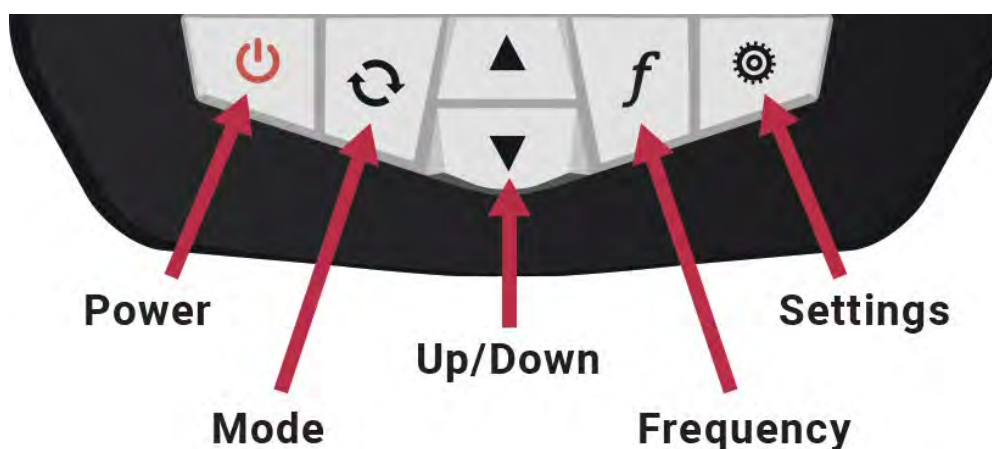

7.2 User Interface

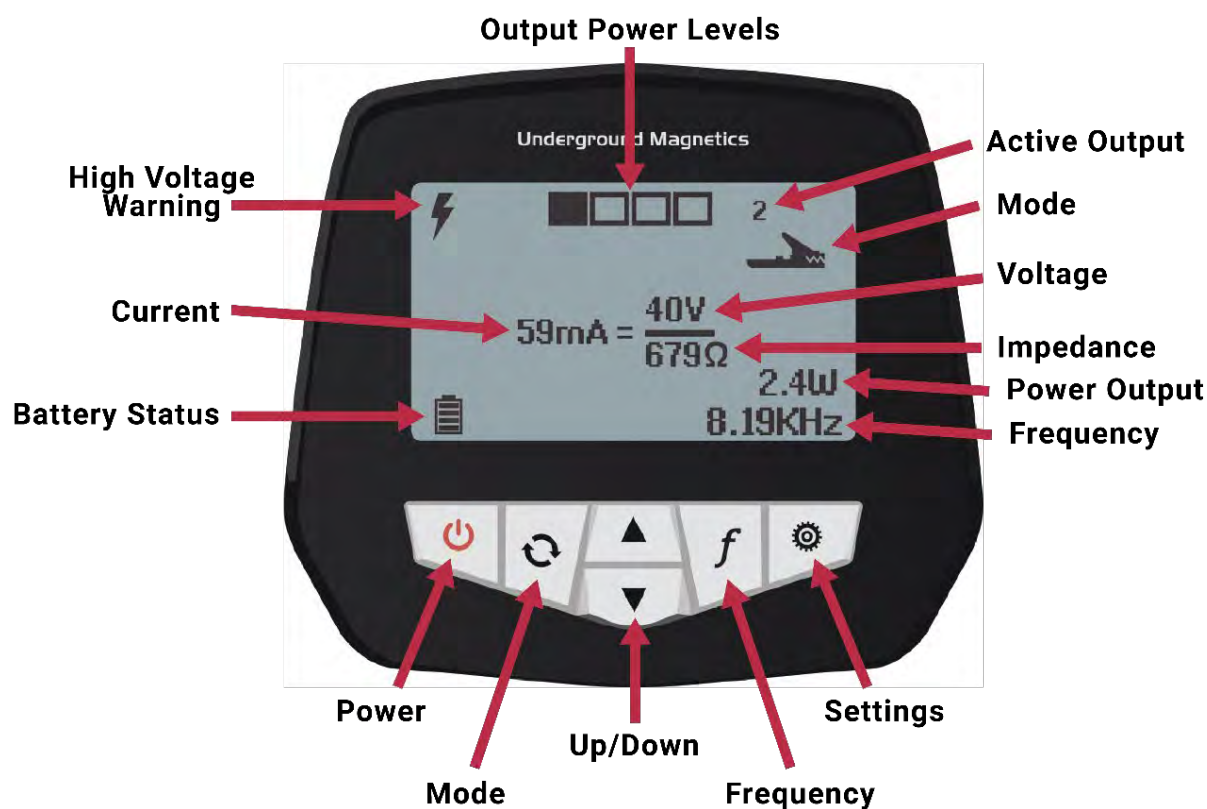

There are two main contexts for the Transmitter: Main Screen and Menu Screen. The keys can have distinct functions depending on context. The keypad is used to control the Transmitter.







Screen Information

Mode	The current Operating Mode
Power Output	Transmitter output power (W)
Active Output	Indicates which Output Port is active
Frequency	Operating Frequency
Battery	Battery Level
High Voltage Indication	Direct Connect ONLY: Indicates that a high voltage has been detected.
Current	Measured Output Current (mA)
Voltage	Measured Output Voltage (V)
Impedance	Measured Output Impedance (Ω)







7.3 Key Functions

Following is a description of the key functions:

Main Screen Key Functions

	POWER	Press or press and hold to power OFF
	MODE	Change the mode of the Transmitter. Mode will cycle between connected accessories and Induction Mode
	UP	Increase output power
	DOWN	Decrease output power
	FREQUENCY	Change the operating frequency
	SETTINGS	Opens the settings

Menu Key Press Functions

	POWER	Press exits to Main screen
	MODE	Exit the menu or sub menu
	UP	Move the selection up
	DOWN	Move the selection down
	FREQUENCY	Change a setting or enter a sub menu
	SETTINGS	Opens the settings

7.4 User Menu

The Transmitter can be customized to user preferences and features that can be switched on or off using the User Menu.

Press the **SETTINGS** key to enter the menu.

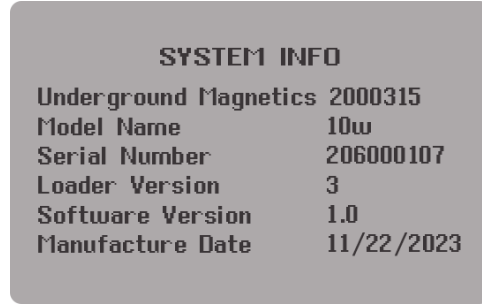
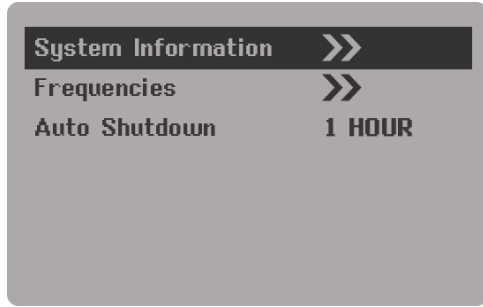

Auto Shutdown:

If no keys are pressed, NEVER, 1 or 2 HOURS

System Information:

Manufacturing data and Software Version

Frequencies

Enables the Active Signal Frequencies that will be available when pressing the **FREQUENCY** key during use.

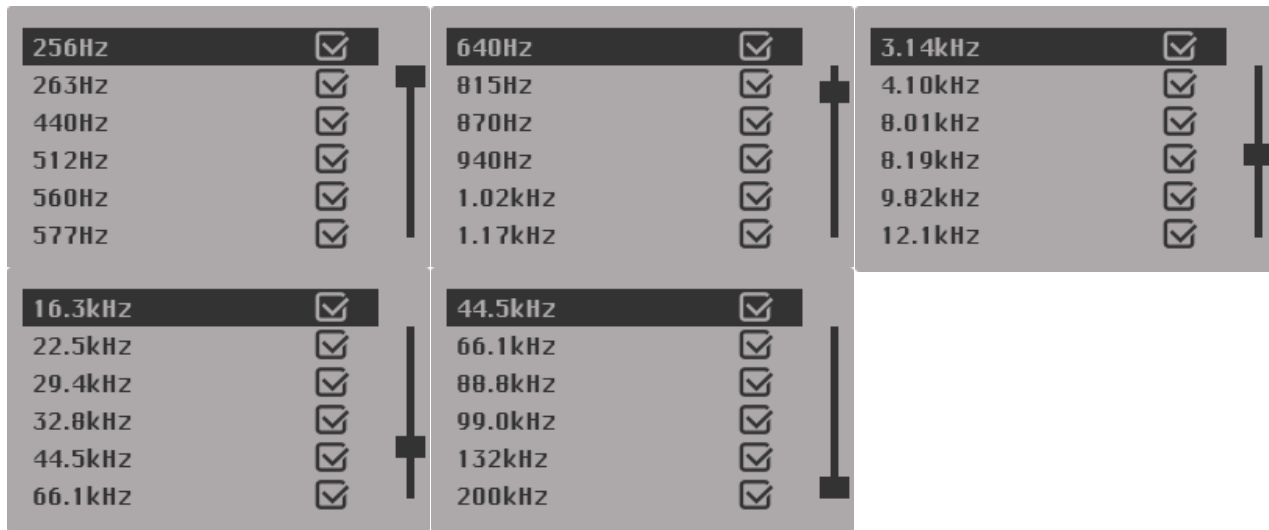

7.5 Operating Modes

The 10w Transmitter has 2 Output Ports and 3 Operating Modes.
Operating Modes: Direct Connection, Signal Clamp, and Induction

Any combination of accessories can be connected to the output ports.

- ❖ **No Accessories:**
When powered ON, the Transmitter will default to Induction Mode.
- ❖ **Connect Accessory:**
The Transmitter will switch to that accessory.
- ❖ **Disconnect Accessory:**
The Transmitter will switch to the other connected accessory.

The **MODE** key can be used to change the active accessory. It will cycle between connected accessories and the Induction Mode.



7.5.1 Direct Connection

Uses the output connectors to connect to a cable or pipe.
Generally, the best method of locating a cable.

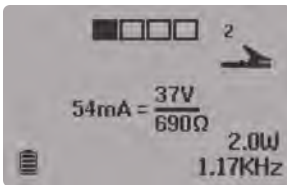

Select Mode



Mode Icon

7.5.2 Signal Clamp

Used when a particular cable within a group of cables needs to be isolated.

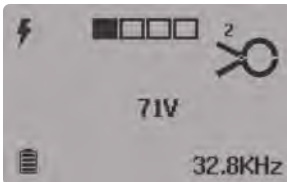

Select Mode



Mode Icon

7.5.3 Induction (3.14kHz and up)

When access to a cable is restricted, or no physical connection can be found, the Induction method may be used.

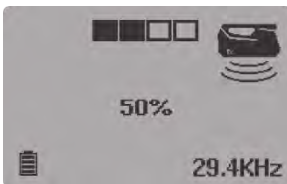

Select Mode



Mode Icon

⚠ ATTENTION

Induction Mode is only available for frequencies 3.14kHz and higher.

7.6 Output Power

The Transmitter output signal is adjustable in 4 levels and can be selected to suit the Locating situation.

The direct connected output signal increases with increasing output voltage level. The battery power required is reduced with lower line impedance at each Output Power level and extends battery life.

FCC and CE limit the maximum transmitter power by frequency as follows:

Frequency Range	10w max output	FCC / CE Limit
Up to 9kHz:	10 Watt	Unlimited
9kHz to 45kHz:	10 Watt	10 Watt
Above 45kHz:	1 Watt	1 Watt

TIPS

Connected Line impedance can be reduced by using a low Frequency signal, improved earth grounding or by applying a remote earth. These steps will allow the Transmitter to maximize the output Locate signal and extend battery life.

7.7 Operating Frequency

7.7.1 Standard Frequencies

The Transmitter is shipped with commonly used Frequencies:

256Hz, 263Hz, 440Hz, 512Hz, 560Hz, 577Hz, 640Hz, 815Hz, 870Hz, 940Hz, 1.02kHz, 1.17kHz, 3.14kHz, 4.1kHz, 8.01kHz, 8.19kHz, 9.82kHz, 12.1kHz, 16.3kHz, 22.5kHz, 29.4kHz, 32.8kHz, 44.5kHz, 66.1kHz, 88.8kHz, 99kHz, 132kHz, 200kHz

The Active frequency is set using the **FREQUENCY** key to scroll through all the Active Frequencies enabled in the User Menu FREQUENCIES

TIPS

Lower frequencies are preferred and deliver better Locates in the Direct Connect Mode. Higher frequencies are preferred in the Induction Mode.

Induced signal coupling to adjacent utilities increases with operating frequency. The ratio of target line signal to coupled signal is not affected by output power level.

7.8 Warnings and Alerts

The Transmitter has detection circuits to alert the user to the presence of hazardous voltages.

The Transmitter will check for the presence of High Voltage on the output Ports when the Output Power is set to the Standby Level (No bars).

These warnings are active when using the Direct Connection and Signal Clamp Accessories. There are two warning levels:

HIGH VOLTAGE: 100V or more

Potentially Dangerous:

TIPS

The Transmitter may momentarily turn off and then resume operation in a SAFE Mode.

Reduced performance when using low output frequencies

HIGH VOLTAGE Hazard icon.

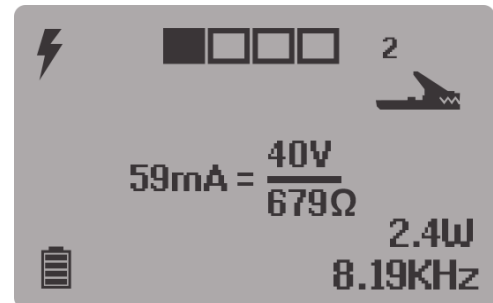

VERY HIGH VOLTAGE: 250V or more

Potentially Lethal:

TIPS

The Transmitter cannot be used.

The Transmitter may be damaged.

Turn off the Transmitter and carefully remove the Accessory

VERY HIGH VOLTAGE Hazard icon.



To provide the safest process for the user:

7.8.1 Direct Connection

0. With the Transmitter turned OFF
1. Connect the Direct Connection Leads to the Transmitter Output Port
2. Connect the BLACK Direct Connect Clip to GROUND
3. Connect the RED Direct Connect Clip to the TARGET LINE
4. Power ON the Transmitter with the output set to Standby (zero bar signal output level).
5. The presence of a Dangerous or Highly Dangerous voltage is indicated on the LCD screen.

7.8.2 Signal Clamp

6. With the Transmitter turned OFF
7. Connect the Signal Clamp to the Transmitter Output Port
8. Clip the Signal Clamp around the cable to be traced.
9. Turn ON the Transmitter with the output set to Standby (zero bar signal output level).

8. Accessories

Connection Leads

These are used to make a direct connection from the Transmitter Output to Pipes, Cables, or Utility Tracer Wire. When plugged into the Transmitter Accessory Port this enables a Tracing signal to be applied to the Utility line.

A Long Ground Stake improves connection to the ground in very dry ground conditions.

WARNING

For safety, always connect the **BLACK LEAD** first, to a ground point or using the Ground Stake inserted into the ground. Then connect the **RED LEAD** to the Utility.

Connecting to a live cable can result in an electrical shock and potentially lethal.

Precautions: Never connect the output cable directly to an electrical live cable. Only authorized personnel should make connections to pipes or cables. The Transmitter will display a warning when a High or Dangerous voltage is present.

CAUTION

Take care when handling exposed or non-insulated connections of cable sets, earth stake or connecting cable.

Precautions: Make all connections before turning the Transmitter ON and increasing output signal. Do not remove transmitter earth stake with output signal present. Notify others who may be working on or around the cable.

Remote Ground Lead

A Remote Ground Lead is provided to enable a Ground Connection further away from the Transmitter, this may be necessary when operating on concrete or asphalt areas. The Remote Ground may also be used for grounding the far end of a utility to reduce the signal impedance and improve the Locate quality.

Signal Clamp

The Signal Clamp can be used with both the Receiver and Transmitter and used to help identify individual cables or where cables are in use or electrically live. A female ¼-20 threaded connector enables an extension pole to be attached and extend the reach of the Clamp safely within underground chambers or overhead cables beyond convenient reach.

Transmitter Mode: For the Clamp to work effectively, the Output signal must flow in both directions, operation may require an end of line ground termination. Higher Transmitter Output Frequencies are more efficient, but the Transmitter signal may also couple to adjacent lines. Where possible use the lowest effective Transmitter Output Frequency.

Receiver Mode: When used with the Receiver, the Signal Clamp can be used to help identify an individual cable carrying the Transmitter Output Signal within a bundle of cables.

WARNING

When using the Clamp Accessory a hazardous signal may be present causing personal harm

Precautions: Do not use electrical cables that have impaired or no insulation. Contact qualified people and follow all standards and requirements for disconnecting or grounding cables. Do not remove any safety bonding unless authorized.

Hazardous voltage may be present on plug of the Clamp Accessory when clipped over a live cable.

Precautions: Connect the Clamp to the Transmitter or Receiver before clamping around a live cable

Equipment Bag

The supplied equipment bag enables the Transmitter and Accessories to be conveniently stored and carried on site while providing increased protection from accidental damage. The Transmitter can be operated with accessories connected. The Li-ion battery may be replaced without removal from the equipment bag as well.

9. Using the Utility Locating System

The Receiver can be used on its own to detect passive Power and Radio signals or in combination with the Transmitter to also detect the Transmitter Output Signal, it is always preferred to use a combination of methods, a systematic approach combining different signal frequencies to build up the best understanding of the underground situation, best quality Locates and reliability of documented results.

Users should consider using one or more applications techniques depending on the site conditions, their area of operations and responsibilities. Many companies have Standard Operating Procedures (SOP's) or use Specialist Technicians to carry out Utility Locating. Where possible use all established procedures and resources.

Best Practice locating methods using Direct Connected low and then high frequency Active Signal tracing and Passive Detection Modes will result in verification and Locates of each known Utility. Potential detection of any additional unknown or abandoned utilities will minimize the risk of utility damage during groundwork or boring operations.

TIPS

For individual utility identification, a combination of Active methods using Direct Connection or use of the Signal Clamp is preferred.

Use the lowest effective Transmitter Output Signal Frequency, for best accuracy in complicated site conditions with adjacent or interconnected utilities.

Always Trace and Locate each utility in turn.

For multiple Utility Locating use a combination of methods, check accuracy of results against available information.

Consider using other detection technologies including Ground Penetrating RADAR (GPR).

For critical Locates expose the Utility using vacuum extraction machinery or by hand digging.

Combine results with utility maps and compare them with physical site indicators of utility presence, cabinets, pedestals, or vaults.

Document results in accordance with Site or Client requirements and where possible minimize recording poor accuracy information.

Documentation may be to a recognized utility engineering standard including ASCE 38-22 guideline using GIS software and digital GPS or Survey equipment.

CAUTION

The Receiver will fail to detect electrical services if set to the incorrect setting.

Precautions: Before use, ensure the Receiver is setup to be compatible with the power grid 50 or 60Hz

The absence of a positive indications does not guarantee nonexistence of a service.

Non-metallic or other abandoned services without a signal may be present.

Precautions: Always excavate with care.

ATTENTION

The user should use available mapping information to Locate carefully and accurately each known utilities in turn and minimize the potential of utility damage during operations. This process provides highest reliability of locating both known and importantly can detect unknown or abandoned utilities.

9.1 Locating Process

9.1.1 Information

All plans and maps of buried utilities should be sought from Operations Managers, Project Engineers, or utility owners. Information should be checked on site to confirm understanding, decide on any risk reduction steps and identify if there is any information that is uncertain or potentially incorrect. If necessary, subcontract a specialist Utility Survey to thoroughly locate all utilities, flag, or spray/mark, and if necessary, digitally document all detected buried utilities.

9.1.2 Inspection

Inspect the site for signs of buried utilities such as:

- ❖ Recent trenching
- ❖ Buried cable markers
- ❖ Overhead utilities that run down pole and underground
- ❖ Gas meters
- ❖ Valve sites
- ❖ Drains or manhole covers

This information should be cross checked with supplied information, operations planning and Engineering designers to ensure utility clearances are achievable, operations and design planning adjusted so that key identified risks can be mitigated or completely avoided.

9.1.3 Locating

The Contractor should use available mapping information to Locate each documented utility to minimize the potential of mis locates. This process can identify other unknown or abandoned utilities not on the map.

9.1.4 Best practice

Many companies have Standard Operating Procedures (SOP's) or use Specialist Technicians to conduct Utility Locating. Where possible use all established procedures and resources.

Best Practice locating methods combine using Direct Connected low and then high frequency Active Signal tracing and the repeat Locates using Passive Modes. Combining results improves verification and Locates of each known Utility. Potential detection of any additional unknown or abandoned utilities will minimize the risk of utility damage during later ground works operations.

WARNING

The absence of positive indications does not guarantee nonexistence of a service.

Non-metallic or other abandoned services without a signal may be present.

Always excavate with care.

CAUTION

Investigate further with the information provider, utility owner or site Supervisor if any information seems incorrect or is not clear.

9.2 Utility Locating

When Line Locating a Utility Pipe or Cable, the Receiver can be used in any Locate Modes for user preference resulting in a Peak or Null indication when over the Line and, when activated, Left/Right indicators to simplify and speed up each Locate. A combination of Locates using Active and Passive Modes and Peak and Null Locate Modes helps to interpret the underground situation, assess the accuracy and reliably document the results.

The Receiver should be held vertically with the display forward and swept to the left and right across the anticipated direction of the utility line. When a Utility is detected the signal display changes, and the compass indicator always points in the direction of the Utility path.

TIPS

Start Locating with a high gain setting with an indicated reading less than 20. As a Utility is detected the indicated reading will change, increasing in Peak Modes and reducing in Null Mode, adjust the gain to maintain an on screen reading less than 90 and complete the Locate.

Complete Locates slowly for best accuracy and understanding. Use marker flags, spray paint or other documentation methods to mark the Locate.

Multiple Locates will form a line of the Utility path and may include Tee splices or changes in direction or depth. It is always useful to better understand these situations, particularly around a critical point of interest.

Avoid using too much paint to mark the Locate to ensure it is easily understood by others. Marking symbols should comply with established codes and the correct use of color for utility identification.

9.2.1 Depth and Signal Current Reading

The Utility Depth and Transmitter Signal Current are displayed automatically as part of the Locate process Set display units in the User Menu preference settings. The reading has the best quality after completing the Locate process.

The Transmitter Current reading can be used to help tracing and identification of the built structure of the Utility. For example: When passing a Tee connection, the Current reading will reduce. The Current reading can be used to help confidence when tracing between Locates either side of inaccessible areas, such as road or creek crossings, or where there is a change of depth and signal reduced. A significant reduction in current may indicate a change in the Utility structure such as an insulated joint break, replacement nonmetallic section or a spur Tee connection.

CAUTION

The base of the Receiver must be resting on the ground for most accurate depth reading.

Precautions: The Receiver must be in contact with the ground for best accuracy depth reading. Depth readings are determined from the base of the Receiver to the center of the pipe or cable. The distance to the top of large diameter pipes will be less than the depth reading.

Depth readings are subject to several factors that can reduce accuracy and are provided as a guide only.

Precautions: Avoid taking depth readings near electrical apparatus or large conductive structures such as safety fencing or in areas of steel Rebar reinforced ground. Never use the depth reading to define mechanical digging clearance or utility depth. Do not take depth readings near bends or Tees in the line. Move at least 10ft (3m) from a bend or Tee for best accuracy. Always follow local safe digging guidelines. If in doubt ignore a single depth reading or repeat at multiple locations.

TIPS

If necessary, compare depth results using different Transmitter Signal Frequencies. Repeat Locates away from sources of interference such as electrical equipment cabinets or metal structures such as fencing or safety barriers.

Best quality depth reading can be confirmed when the Peak and Null Mode Locates are in the same position. Where there the Peak and Null Locates differ, due to complex multi utility conditions or near metallic structures. Use the Peak Mode for best results.

Avoid using depth results within 10ft (3m) of a Tee or a notable change in direction or depth. Nearby Locates can help identify the best depth reading.

Auto depth reading provides a time saving and convenient indication for Tracing and multiple Locates. The reading is most accurate when directly over the utility and the Compass indicator aligned.

9.3 Active Locating

Active Locating uses the Transmitter to apply a Tracing Signal to the utility or tracer wire. This provides the Receiver with a very precise signal to detect, trace and locate and is recommended for tracing individual Utilities and identification. When tracing multiple utilities in complex situations, this repeated Locating methodology creates a map and best understanding of the below ground situation.

The Transmitter Active Frequency can be selected from a range of preset options, set in the Transmitter User Menu, to suit different Locating applications.

Low frequency ($\leq 3\text{kHz}$)

Best for tracing known utilities with highest Locate accuracy and tracing distance when connected by Direct Connection or Signal Clamp Accessory.

Preferred method for Locate accuracy and depth estimation.

Medium frequency (≥ 8 and $\leq 65\text{kHz}$)

Best for high impedance direct connected tracing and Induction of insulated joint metallic pipes or insulated utilities.

Convenient for general Locating and suited to a range of different operating conditions.

High frequency ($\geq 65\text{kHz}$)

Best for area wide induction onto any utility in the immediate area or to detect adjacent unconnected utilities in the same area.

Ideal for detecting abandoned or unknown utilities in the adjacent area.

Applications techniques and choice of Active Frequencies enable individual utilities to be reliably detected, located, traced, and identified. Most common method used by One Call and Utility Mapping Technicians and specialist Civil Engineering Surveyors.

The Transmitter signal can be connected to a utility either directly where there is access using the connection leads, and it is safe to do, or by using the Signal Clamp. Where there is no direct access or actual location is unknown use remote Induction.

TIPS

Use of a combination of Locating methods and signal frequencies may be helpful. Results can be combined to verify Locates to highest confidence.

The Frequency Analyzer feature can be used to choose the best combination of low signal interference and Active signal frequency.

Peak Mode locating results in the most reliable and accurate Locate.

Null Mode may be preferred for fast multiple Locates, such as route tracing, accuracy is reduced where there are multiple Utilities or signal distortion.

Critical Locates should be exposed by hand digging or using a vacuum extraction machine to verify results.

Trace the Utility to a known location to help identify and provide the highest confidence in the results.

Switch to a High frequency signal to help detect unknown or isolated and adjacent Utilities. Ideal within congested areas such as a Utility Right of Way.

9.3.1 Direct Connection

The Transmitter can be used to apply a signal to any known utility lines that can be Located. For the most reliable results, a Direct Connection of the Transmitter signal to a known Utility is preferred.

1. Connect the supplied Direct Connection Leads to either Transmitter Output Port (Mode will auto select)
2. Connect the Return Signal, **BLACK LEAD**, through one of the following:
 - a. Dirt/ground
 - b. Common ground connected utilities
 - c. Induced into adjacent utilities.
3. Connect the Transmitter Output Signal, **RED LEAD**, directly to the utility.
4. Select an Output Frequency (less than 10kHz for precision locate)
5. Use the Receiver to pinpoint.
6. Mark the path of each utility line with spray paint, marker pegs or flags.

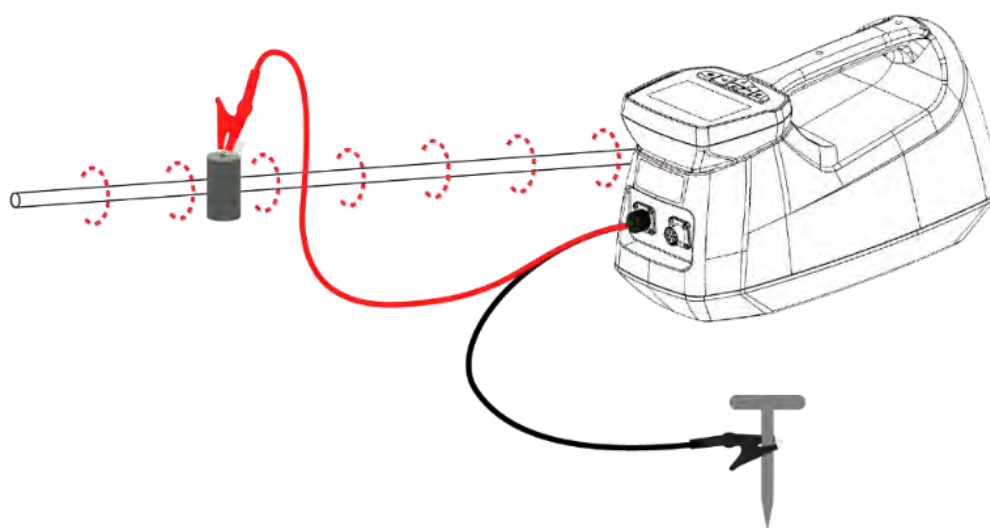

⚠ WARNING

For Safety, the **BLACK LEAD** should be connected to a convenient ground point or using the supplied Ground Stake pushed into the ground and followed by connecting the **RED LEAD** to the Utility or tracer wire.

⚠ ATTENTION

The lowest signal frequency reduces induced signal returns, increases ability to trace and identify a single utility, trace that utility further and for most common locating application is the preferred method to deliver the best locate results.

💡 TIPS

Position the Ground Stake at 90 degrees to the expected path of the utility and position away from any other adjacent utility lines. Improves Locate accuracy.

An improved Ground Stake connection can be achieved with the supplied Long Stake or by repositioning the Stake to shaded, more conductive ground.

A quick and easy way to connect the Ground Lead is to use a buried metal conductive structure, such as a metal pole, equipment cabinet or drainage culvert.

9.3.2 Transmitter Clamp

The Transmitter Clamp is an ideal solution where there is no authority to isolate a cable, is electrically live or where user danger could result.

1. With the Transmitter powered OFF, Connect the supplied Clamp to either Transmitter Output Port
The Mode will automatically be selected.
2. Position the Clamp around the cable/utility you are locating.
3. Verify the Clamp is correctly fitted and closed around the utility.
4. Power ON the Transmitter
5. Select power output level.
6. Select an Output Frequency (less than 10kHz for precision locate)
7. Use the Receiver to pinpoint.
8. Mark the path of each utility line with spray paint, marker pegs or flags.

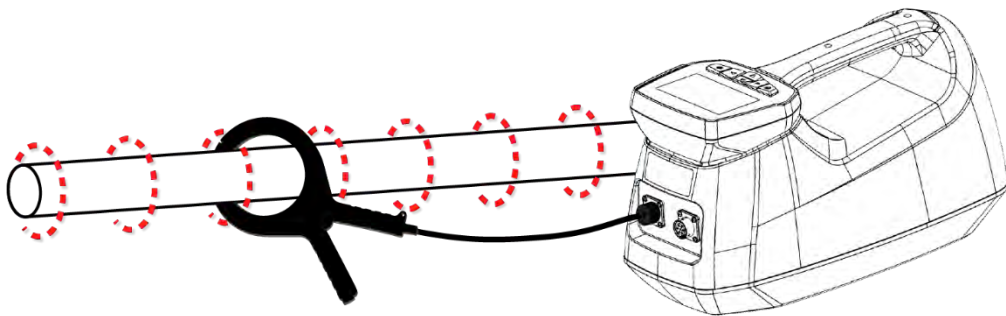

⚠ WARNING

For safety connect the Clamp to the Transmitter and then clamp the cable.

💡 TIPS

Ensure the Clamp is correctly fitted and closed around the utility. Any dirt or corrosion at the open or hinge ends will reduce the performance of the Clamp.

For the best results use the Lowest effective Transmitter Output Signal Frequency.

Common bonded or transformer coupled cables will also carry the tracing signal. If authorized to do so, remove common bonding.

A higher frequency Active Signal may improve detection reliability and increase tracing distance.

The highest signal current will be present on the target utility and may help identification.

Use a high frequency signal and maximum Output Power to increase ground induced current and maximize potential detection of adjacent utilities.

9.3.3 Induction

Where there is no access to any utility lines or their position is unknown, Induction Mode can be used.

1. Remove Grounding Rod or any other conductive objects from the Locate area.
2. Place the Transmitter parallel and directly over a buried utility as shown
Note: the strongest induction signal is directly below the Transmitter.
3. Power ON the Transmitter
4. Select an Output Frequency greater than 3.14kHz.
5. Adjust the Power Mode
6. Use the Receiver to pinpoint.
7. Locate at least 20ft (6m) from the Transmitter, mark with spray paint, pegs, or flags.

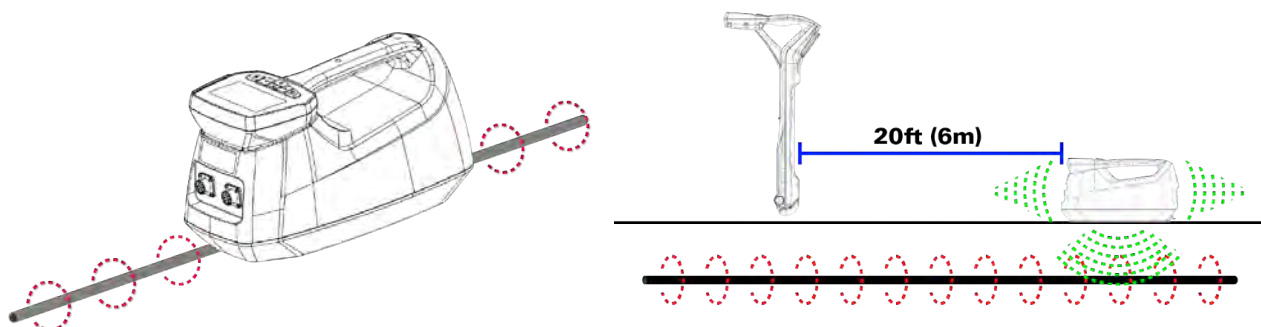

⚠ ATTENTION

The highest Output Frequency couples to the Utility best but may also couple to adjacent lines. Use the lowest effective signal frequency.

💡 TIPS

The distance between the Receiver and Transmitter must be at least 20ft (6m) to prevent as an Air Lock of signals between the equipment,

The efficiency of Induction reduces with increasing utility depth. Position at the shallowest depth, increase the signal output Power and frequency.

The induction signal couples to adjacent utilities. This can be minimized when there is an opportunity to place the Transmitter away from other utilities.

To extend the tracing distance, reposition the Transmitter to the last known Locate.

Place the Transmitter near to a utility at a known location, the base of an overhead utility pole where the cable goes underground, at a duct chamber or next to an equipment cabinet.

Where a Locate is required close to the Transmitter position, Locate the Utility at least 20ft (6m) away from the Transmitter and reposition the Transmitter to that Locate so that you can complete Locates around the original position.

Induction Null

This can be useful for locating in congested multi utility sites and improving Locate accuracy of other utilities and a better understanding in complex and congested site conditions.

10. Lay the Transmitter on its side.
This will reduce the chance of the signal coupling to a utility directly below.
11. Move the Transmitter over each utility in turn and make Locates on other Utilities for best results.

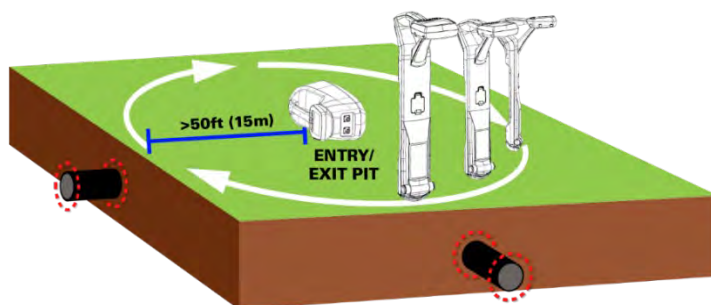

9.3.4 Sonde Locating

The Sonde is a self-contained Signal Transmitter that is Located differently to other Utilities. It is inserted into a nonmetallic pipe or sewer and used to locate blockages or trace the pipe. A Sonde is normally connected to a flexible push rod or may also be integrated into pipe inspection or other specialized equipment such as HDD or auger boring machines. The Sonde is directly below the Receiver where there is the strongest signal. Repeated Locating of the Sonde as it passes through a pipe enables the route of the pipe to be traced, pinpointing blockages, depth estimation and route heading.

Select the same Active Frequency as the Sonde, most common are 512Hz, 640Hz, 8192Hz or 32768Hz

Twin Sweep (Omni Directional) or SWEEP Mode

For simplicity of use, a maximum numeric signal reading is displayed when determining the heading and then moved over the Sonde. SWEEP Mode allows locating at greater depth.

NULL Point Locating

It can be used to help locate and pinpoint a Sonde at great depth and with improved left and right accuracy.

TIPS

When tracing a pipe, start marking Locates at the first opportunity after inserting the Sonde and repeat Locates every 10ft (3m) and mark.

It may be preferred to push the Sonde to a known far end location, such as a pipe access chamber or septic tank. Withdraw the Sonde marking each Locate.

The Sonde will lie at the bottom of large diameter pipes, depth estimation is to the center of the Sonde, readings will be deeper than the top of the pipe.

At depths greater than 10ft (3m), improved Locates and depth estimation can be achieved using NULL point Locating method.

9.4 Passive Locating

Passive signal locating provides the easiest and most efficient means of locating both known and unknown utilities but does not identify a specific utility. Investigate any indications and consider using Active Signal Induction to better understand the underground situation.

Mark detected Utilities in accordance with site or company regulations, contact a supervisor, client or take damage prevention actions, as necessary.

Passive Locating uses a combination of electromagnetic signals that may be conducted by the Utility. Also provides the opportunity to detect unknown Utility lines as part of a Damage Avoidance process and to verify Utilities detected and Located using Active Locating methods.

Power

Due to electrical Power distribution networks, normally at 50 or 60Hz and their harmonically related signals. Power cables and utilities carrying ground connected or induced return currents. Available in all Locating Modes.

Radio

Due to low frequency radio communication transmissions, ground connected or induced ground currents can be used to locate most conductive pipes and cables. Radio is only available in Twin Mode.

Corrosion Protection

Pipeline corrosion protection systems, also known as Cathodic Protection systems, are derived from the Power network, normally at 100 or 120Hz. This Mode can be used to detect and identify pipelines. Available in all Locating Modes.

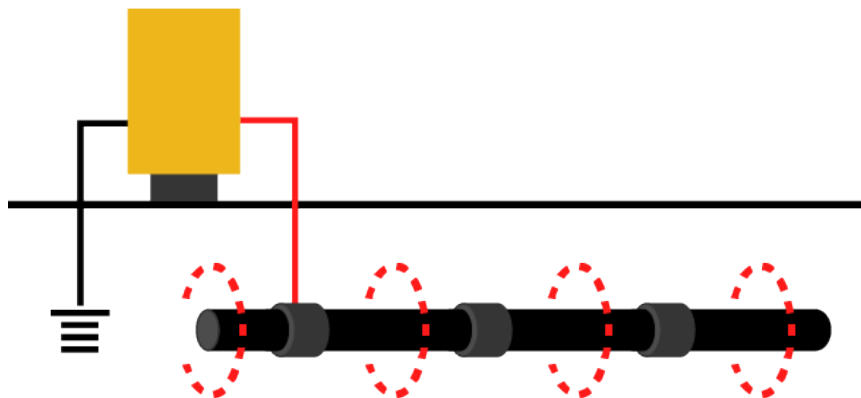

TIPS

Always use both Power and Radio Passive Modes to search for best detection performance and as part of utility damage prevention measures.

Passive Modes can also be used as part of a Utility Survey process to verify utilities Located and may also detect additional or unknown utilities.

Alternative detection technologies such as GPR can be used to verify Locates as an extra check.

Hand or machine dug excavations and trenches may be necessary to positively confirm results in critical areas.

Most utilities carry a combination of Power and Radio signals, Passive detection does not identify the Utility type.

9.5 Passive Detection

9.5.1 Perimeter Search

Where a small area is searched, a “360 Degree Perimeter Search” should be conducted. This should be at least 3ft (1m) larger than the area.

Power Frequency

1. Select the Twin Peak or Twin Sweep (Omni Directional) Mode
2. Select Grouped Power 50/60Hz for best detection reliability.
3. Adjust the Receiver gain until 20% display of background signal noise.
4. Walk slowly around the perimeter.

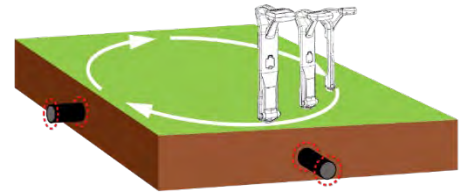

Note any increase in signal that indicates the presence of a buried utility.

Radio Frequency

1. Select the Radio Frequency Mode
2. Adjust the Receiver gain until 20% display of background signal noise.
3. Walk slowly around the perimeter.

⚠ ATTENTION

Note any increase in signal that indicates the presence of a buried utility.

9.5.2 Large Area Search

A larger area can be searched to detect and Locate utilities crossing or running parallel to the path.

Power Frequency

1. Select the Twin Peak or Twin Sweep (Omni Directional) Mode
2. Select Grouped Power 50/60Hz for the best detection reliability.
3. Adjust the Receiver sensitivity until 20% display of background signal noise.
4. Orient the Receiver to locate any utilities that may pass across the path.

Radio Frequency

1. Select the Radio Frequency Mode
2. Adjust the Receiver gain until 20% display of background signal noise.
3. Adjust the Receiver sensitivity until 20% display of background signal noise.
4. Orient the Receiver to locate any utilities that may pass across the path.
5. Walk along the path at a slow walking pace.

⚠ ATTENTION

Note any increase in signal that indicates the presence of a buried utility.

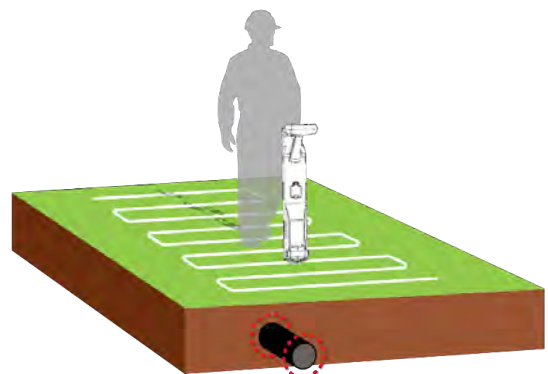
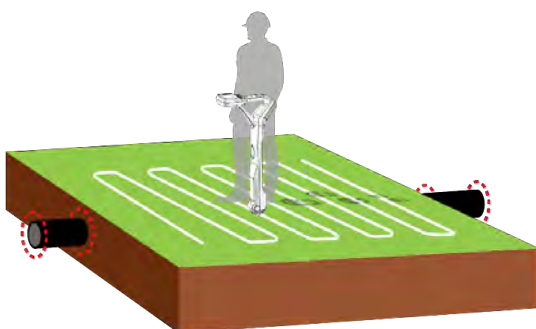

9.5.3 Area Avoidance

1. Place the Transmitter on the ground and on its side within the target area.
2. Select the Twin Peak Mode
3. Select a Transmitter Output Frequency greater than 3kHz
Note: Recommended frequencies from 45kHz to 88kHz.
4. Perform a 360-Degree Perimeter Search
 - a. This should be at least 20ft (6m) larger than the target area.
5. Adjust the Receiver gain until 10-50% display of background signal noise.
6. Walk slowly around the perimeter
Note: Any increase in signal that indicates the possible presence of a buried utility.
7. The Transmitter position should be moved to each corner of the pit (A, B, C and D) to maximize utility detection reliability.
8. Repeat this process at each position.

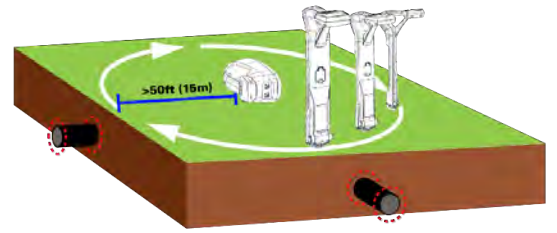

9.5.4 Two Man Area Sweep

The area can be searched as a 2-person operation using the Transmitter and Receiver. Locating known and unknown utility crossing within the area.

1. While walking in parallel
2. One user carries the Transmitter.
 - a. Waist height, horizontally, and on its side
3. Another user carries the Receiver.
 - a. Rotate the Receiver 90-degrees.
4. Both users walk in tandem from one edge of the target area to the other
 - a. Remain 20ft (6m) apart.
 - b. User with the Receiver walks 3ft (1m) ahead to ensure most reliable detection.
5. Repeat this process 90-degrees to increase likelihood of detecting utilities.

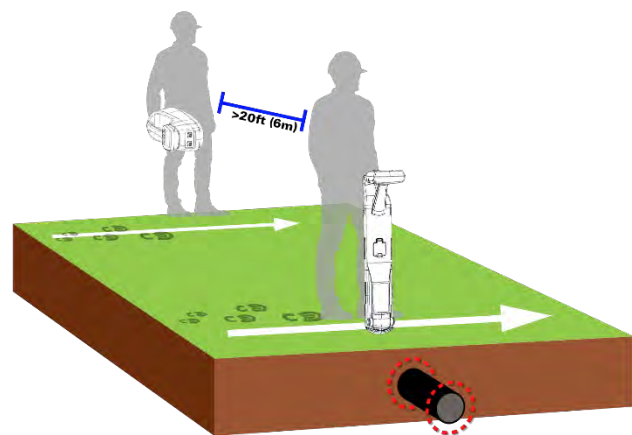
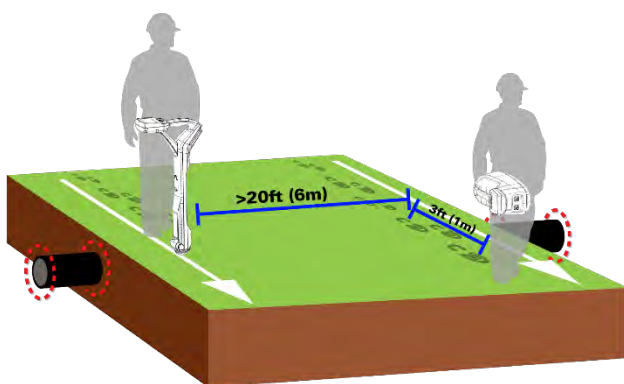

9.6 Receiver accessories

Accessories can be used to extend the range of uses for the Utility Locating System and may be used to increase detection and identification performance in a range of applications.

9.6.1 Receiver Clamp

The Signal Clamp can be used to help identify an individual utility on a cable tray or within a duct system.

The Signal Clamp is connected to the Accessory Port of the Receiver. A Transmitter signal connected to a utility by Signal Clamp or Direct Connection. Clamp each cable in turn to determine the highest signal level present on the identified utility.

TIPS

Use a Low frequency Transmitter signal to reduce unwanted signals on adjacent utilities.

Common bonded utilities will each carry a smaller amount of the Tracing Signal.

If authorized to do so, remove common ground bonds on other utilities within the same group. The correct cable will have the strongest signal.

9.6.2 Data Logging

The Receiver features built-in data logging capability. With 4GB of internal storage, it can store over 16 million records. *(Future Feature Upgrade)*

10. Locating Techniques

The most effective Locating technique depends on several site-specific conditions, Locating objectives and project outcomes. In most cases the objectives include improving personal safety, delivering reliable and accurate Utility Locates. In meeting these objectives there should be lower accidental utility damage, reliable Utility mapping documentation and accurate Engineering design data.

A variety of Engineers, Contractors, Specialist Utility Surveyors and One Call Services providers have developed their own effective approach and Standard Operating Procedures to Utility Locating. These SOP methodologies provide a valuable resource for individual learning and opportunity for improving Locate outcomes. These SOPs should always be followed where known.

10.1 Site observations

Utility maps and plans should be sought and checked to identify the Locating approach or that information is incomplete and additional strategies are needed.

Inspect the site for signs of buried utilities such as:

- ❖ Recent trenching.
- ❖ Buried cable markers.
- ❖ Overhead utilities that run down pole and underground.
- ❖ Gas meters.
- ❖ Valve sites.
- ❖ Drains or manhole covers.

The outcome of any inspection should be cross checked with supplied information, operations planning and Engineering designers to ensure utility clearances are achievable, operations and design planning adjusted so that key identified risks can be overcome.

10.2 Locating

Contractors should review site observations and decide on one or more Locating techniques. Locate each utility in sequence depending on the site conditions, from an identifiable start or end location and within the area of site operations and responsibilities.

Recommended methods, dependent on-site conditions, and authority to access utilities. A combination of Direct Connected Active and Passive signal detection provides the most reliable and accurate results.

Active Detection: Direct or Clamp connection to Trace, Locate and Mark each known utility.

Passive Detection: Cross check Active Locates, detection of unknown or poorly mapped areas.

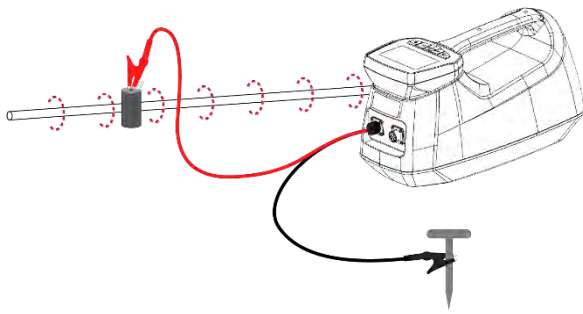

Connect – Connected Utility

1. Connect the Transmitter Ground, **BLACK LEAD**, to the dirt using the Ground Stake or other grounded metal structure.
2. Connect the Transmitter Output, **RED LEAD**, to the utility or tracer wire.
3. Select a Transmitter Output Frequency less than 10kHz (1 to 3kHz recommended).
4. Set the Receiver to Twin Peak or Twin Sweep (Omni Directional) Mode.
5. Adjust the Receiver gain until 10-50% display of background signal noise.
6. Perform a 360-Degree Perimeter Search at least 10ft (3m) distance to detect the Utility.
7. Trace, Locate and mark the Connected Utility.

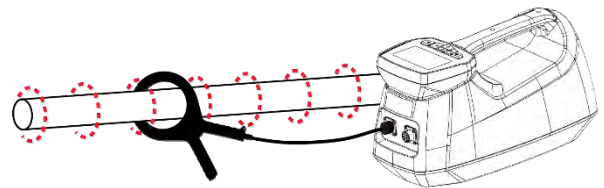

Clamp – Connected Utility

1. Connect the Clamp to the Transmitter and then clamp the Utility cable.
2. Select a Transmitter Output Frequency less than 10kHz (1 to 3kHz recommended).
3. Set the Receiver to Twin Peak or Twin Sweep (Omni Directional) Mode.
4. Adjust the Receiver gain until 10-50% display of background signal noise.
5. Perform a 360-Degree Perimeter Search at least 10ft (3m) distance to detect the Utility.
6. Trace, Locate and mark the connected Utility.

Induction – Adjacent Utility

1. Select a Transmitter Output Frequency greater than 3kHz (45kHz to 88kHz are recommended)
2. Set the Receiver to Twin Peak or Twin Sweep (Omni Directional) Mode
3. Adjust the Receiver gain until 10-50% display of background signal noise.
4. Perform a 360-Degree Perimeter Search at least 10ft (3m) distance to detect any additional Utilities.
5. Detect, Trace, Locate and mark additional Utilities.

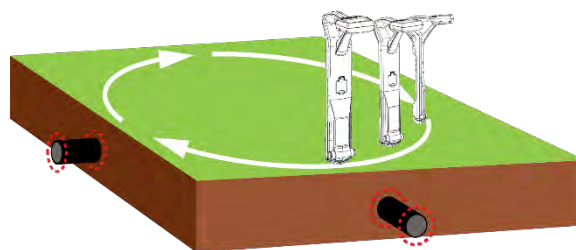
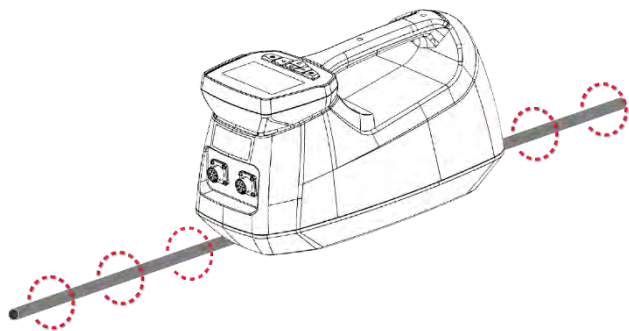

Induction - Convenient

1. Place the Transmitter over the utility and in line with the path.
2. Select a Transmitter Output Frequency greater than 3kHz (Lowest effective is recommended).
3. Increase output power to maximum, reduce if a strong Locate signal is detected.
4. Set the Receiver to Twin Peak or Twin Sweep (Omni Directional) Mode.
5. Adjust the Receiver gain until 10-50% display of background signal noise.
6. Perform a 360-Degree Perimeter Search at least 10ft (3m) distance to detect any Utilities.
7. Trace, Locate and mark additional Utilities.

Passive – Detection

1. Set the Receiver to Twin Peak or Twin Sweep (Omni Directional) Mode.
2. Select any Power mode or Grouped Power 50/60Hz for best detection reliability.
3. Adjust the Receiver gain until 10-50% display of background signal noise.
4. Perform a 360-Degree Perimeter Search at least 10ft (3m) distance to detect any Utilities.
5. For an extended search area, a Grid search pattern North, South, East, West can be used.
6. Trace, Locate and mark additional Utilities.

Induction – Adjacent Utilities

1. Select a Transmitter Output Frequency greater than 3kHz (45kHz to 88kHz are recommended).
2. Set the Receiver to Twin Peak or Twin Sweep (Omni Directional) Mode.
3. Adjust the Receiver gain until 10-50% display of background signal noise.
4. Perform a 360-Degree Perimeter Search at least 10ft (3m) distance to detect any Utilities.
5. Trace, Locate and mark additional Utilities.

Area Sweep – Passive Radio

1. Repeat this process using the Receiver set to Passive Radio Mode.

Area Sweep – Pipeline

1. Repeat this process using the Receiver set to 100/120Hz Cathodic Protection Mode.

10.3 Best Practices

Many companies have developed Best Practices Standard Operating Procedure (SOP) Locating procedures and methodologies that suit their Locating needs and areas of responsibility. Where available these should be followed.

UM has built up wide experience of different Utility locating applications and developed an effective and simple 6 step SOP. This recommendation is highly effective and can be easily followed, adapted, or integrated into established company training programs, also see Appendix for User Instruction Notes.

FREQUENCIES		
870Hz	✓	0 ▶ 25
1.17kHz	✓	0
263Hz	✓	11
8.19kHz	✓	36
99.0kHz	✓	83
88.8kHz	▬	178
3.14kHz	▬	179
32.8kHz	▬	206

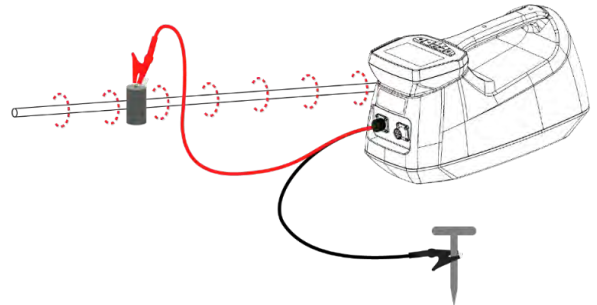

Step 1: Frequency Analyzer

1. Use the Receiver Frequency Analyzer to determine the best Transmitter frequency to use.
2. Walk around the Locate area and monitor the results.
3. The Lowest Frequency is preferred for Locate quality and Tracing distance.

Step 2: Transmitter Direct Connection

1. Connect the **BLACK** Direct Connection Lead to the provided Ground Stake.
2. Connect the **RED** Direct Connection Lead to the pipe/cable.
3. Power **ON** the Transmitter

⚠ ATTENTION

The Transmitter should be turned OFF while running the Frequency Analyzer.



Step 3: Set Signal Frequency

1. Select the lowest frequency as recommended by the Frequency Analyzer.

Step 4: Set Transmitter Output

1. Increase the output level off the Standby Mode.
2. Note the line Impedance (Ω ohms).
3. If the impedance is less than 5,000 ohms, you should have a good Locate signal. Lower is better.
4. Increase or max the power output to levels 1-4 to increase the signal output (current/mA).

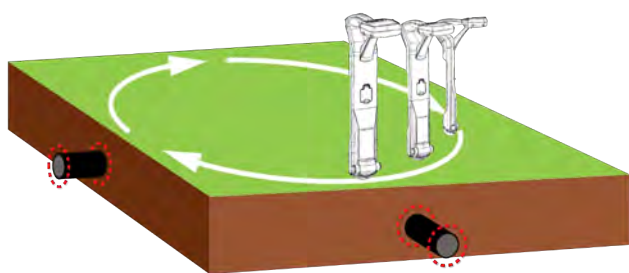

Step 5: Sweep (360-Degree)

1. With the Receiver ON, Select **Twin Peak** or **SWEEP** Mode.
2. Match the Frequency to the Transmitter.
3. Set the initial gain setting between 90dB-100dB.
4. Sweep around the utility connection point.
5. Note all Peak responses.
6. Locate and Trace as required.

Step 6: Locate, Trace and Verify

1. Verify each **Peak and Null** Locate response.
2. If Peak and Null **DO NOT** match up, it is indicative of Signal Distortion. The greater the separation the more likely the locate accuracy is poor.
3. Use an established procedure to verify the Utility's identity.
4. If Peak and Null **DO** match up, follow, and **dot out** the line to the end point to verify the correct Utility has been traced.

Most standard operating procedures require the user to reverse direction and mark out the line back towards the Transmitter connection point.

⚠ CAUTION

If the Transmitter LCD displays a **SMALL** lightning bolt in the top left corner, be aware the line connected has a high level of voltage (up to 110v) that could be harmful to the user.

Consult with your employer's safety compliance practice.

⚠ WARNING

If the Transmitter LCD displays a **LARGE** lightning bolt in the center of the LCD, be aware that the line connected has dangerously high voltage (>250v) that could be life threatening to the user.

DO NOT TOUCH any part(s) of the locating equipment.

Move away to a safe distance and follow your employer's safety compliance practice(s).

⚠ ATTENTION

Note: the lowest frequency does not guarantee signal will successfully carry throughout the length of the pipe/cable.

The user may have to adjust to a higher frequency.

Important: The Transmitter should be turned OFF while performing a Frequency Analysis.

💡 TIPS

In the case of a high impedance > 5,000 Ohms. The line at the far end may not be grounded. In this case, use the supplied second Ground Stake and Wire Spool to ground the far end to reduce the impedance.

Increasing the signal frequency will reduce the impedance.

10.4 Improving Locate Quality

The quality of the Locate depends on site specific conditions including poor choice of operating technique, signal interference and signal distortion due to other utilities and conductive structures. The combination of these factors can result in reduced Locate accuracy and quality.

Metallic structures: These can distort the signal or radiate some of the signal being detected, reducing the accuracy of the Locate. Below ground structures include large buried metallic pipes, storage tanks and reinforcing REBAR mesh. Locating near above ground metal structures including parked vehicles, metal tanks, shipping containers, temporary buildings, metal safety barriers, and mesh fences.

Precautions: Use lower frequency Active signals and verify Locates away from structures.

Electrical interference: Electrical interference from adjacent above or below ground utility lines running on or behind a wall, in common utility trenches or multi utility ducts High power electrical apparatus may cause localize interference. These may include air conditioning equipment, industrial electrical machinery, electrical distribution switch gear or transformers, Mobile phones, Cell towers or other telecommunications equipment cabinets.

Precautions: Look around the Locate area to identify sources of interference and signal distortion.

Marking and Documentation: Where documenting results for Engineering design or use by other contractors always identify areas of reduced accuracy. Avoid delivery of inaccurate information, such as utility clearance and depth information that may be used by other contractors and could result in accidental damage. Shared documents may specifically be used by other high risk operations including utility maintenance, groundwork, trenching, new installations, building foundations or HDD boring.

Precautions: Always identify and document areas of reduced accuracy. Consider NOT providing a depth reading where results are uncertain.

Adjust the operational approach based on site conditions to get the most accurate Locates.

TIPS

Use low frequency Transmitter signals.

Increase Transmitter Signal Power to overcome signal interference.

Use the Receiver Frequency Analyzer feature to help selection of the best Active Signal Frequency with the lowest electrical interference.

Confirm the Locate at multiple positions, comparing results with both Peak and Null Modes. The Peak Mode provides the best Locate.

Locate away from metal structures.

Reposition the ground stake away from other utilities and metal structures such as safety barriers, metal site buildings vehicles or metal fences.

Where REBAR is present, lift the Receiver off the ground 1ft (0.30m) to improve the Locate accuracy.

10.5 Detection- Avoidance

Some sites may have limited utility information or no opportunity to access known Utilities. The Transmitter Induction feature and Receiver operation can be combined with Passive Locating to detect, trace and verify utilities. Larger areas can be efficiently checked, and utilities positions found.

10.5.1 Perimeter Sweep

Used for detection within localized areas, bore pit, fencing, drainage, or other localized groundwork activities.

Active: Place the Transmitter on the ground in 3 different positions within each pit area and set on its side.

1. Select a Transmitter Output Frequency greater than 3kHz (45kHz to 88kHz recommended)
2. Set the Receiver to Twin Peak or Twin Sweep (Omni Directional) Mode
3. Adjust the Receiver gain until 10-50% display of background signal noise.
4. Perform a 360-Degree Perimeter Search at least 50ft (15m) distance.

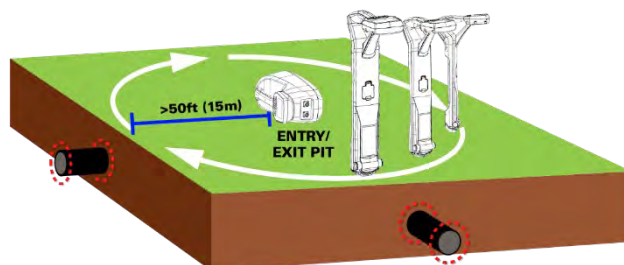

Any increase in signal that indicates the possible presence of a buried utility. Locate and mark.

Passive: Repeat this process using the Receiver set to Passive Power and again set in Radio Mode

10.5.2 Area Search

Used for detecting Utilities crossing or running parallel within larger areas, HDD bore path planning, utility installation or area wide detection. The size of the search should be adjusted to site conditions and project requirements. Multiple searches can be used to increase the effective detection area.

Cross Utility

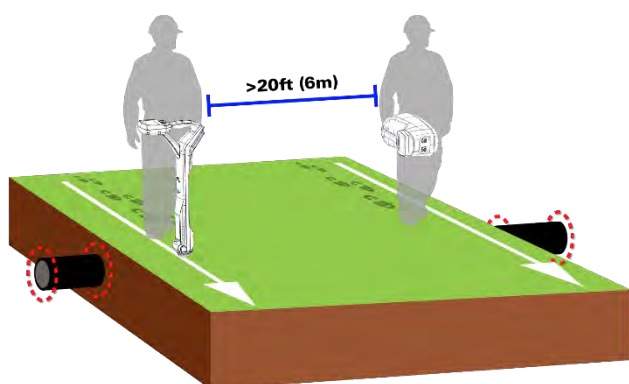

Parallel Utility

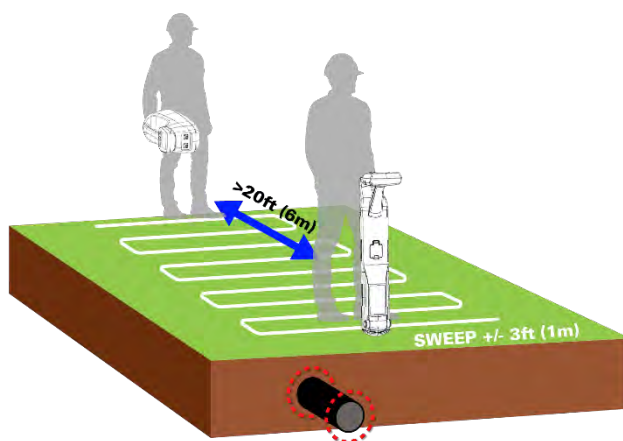

Active: With 2 users, hold the Transmitter on its side and the Locator as shown, walk the path together.

1. Select a Transmitter Output Frequency greater than 3kHz (45kHz to 88kHz recommended)
2. Set the Receiver to Twin Peak or Twin Sweep (Omni Directional) Mode
3. Adjust the Receiver gain until 10-50% display of background signal noise.
4. Walk the Path together at least 20ft (6m) apart.
5. Turn quarter turn and repeat walking across the path.

Any increase in signal that indicates the possible presence of a buried utility. Locate and mark.

Passive: Repeat this process using the Receiver set to Passive Power and again set in Radio Mode.

10.6 Sonde Locating

The Sonde is a self-contained Signal Transmitter that is inserted into a pipe or sewer and used to locate blockages or trace the pipe. A Sonde is normally connected to a flexible push rod or may also be integrated into pipe inspection or other specialized equipment such as HDD or auger boring machines.

The signal transmitted from a Sonde is shaped differently than the signal on a utility, so it must be located differently.

The UM Dual Receiver locates Sondes in either Sweep or Twin Sweep Mode. For both of these modes, the Sonde is located directly under the strongest signal. This can be used to help fast and simple pinpointing, depth estimation and alignment.

Select the same Active Frequency as the Sonde, most common are 512Hz, 640Hz, 8192Hz or 32768Hz.

Twin Sweep (Omni Directional) or SWEEP Locate: For simplicity of use, a maximum signal reading is displayed when over the Sonde. Ideal to Locate a Sonde in an unknown position. SWEEP Mode allows Locates at greater depth.

Precision NULL Point Locate: Can be used to help more precisely Locate a Sonde left and right at great depth for improved accuracy.

10.6.1 Initial Locate - Unknown Sonde Position

When the position of the sonde is not known, initial detection, locating and pinpointing can be slow and difficult.

Follow these steps to quickly find, Locate and then pinpoint the Sonde.

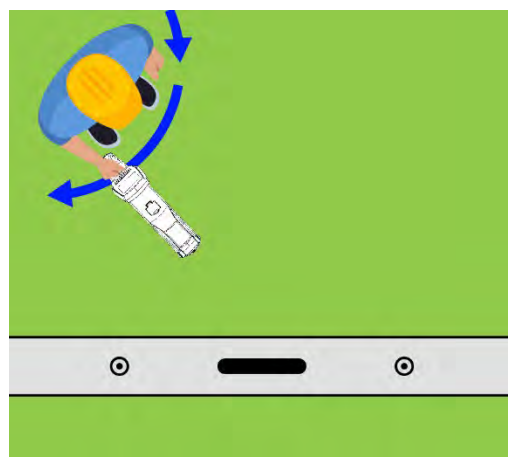
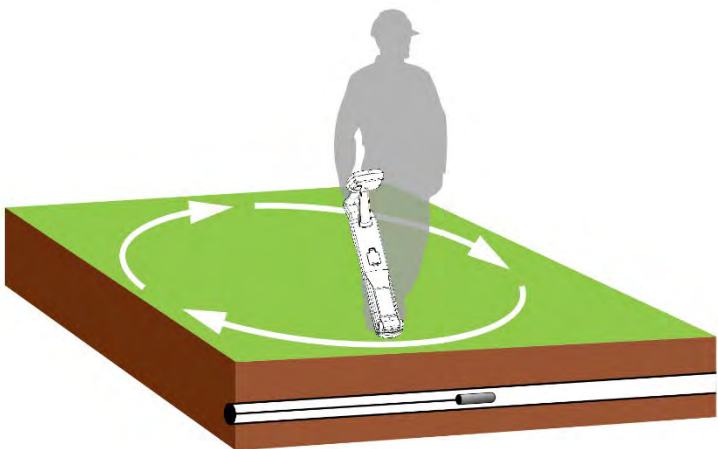

1. Select Twin Sweep Mode 
2. Hold the Receiver at about 45° from vertical.
3. Adjust the signal reading to approximately 20.
4. Make a 360° sweep to find the direction of the strongest signal, then return to the direction with the strongest signal.
5. Adjust the angle of the Receiver until the crosshair align to indicate both the direction and angle to the Sonde.
6. The receiver is now pointed directly toward the Sonde.
7. Move in the direction of the sonde, using the increasing signal to guide you toward the point directly over the sonde and highest signal.

TIPS

Move toward the sonde, adjusting the receiver for maximum signal and reducing the gain as required.

10.6.2 Pinpointing

Once it's known that the Receiver is near the Sonde, follow these steps to precisely locate the sonde.

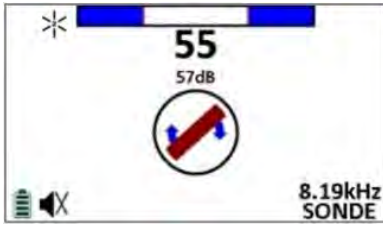

1. Use the rotation arrows to correctly rotate and orient the Receiver.

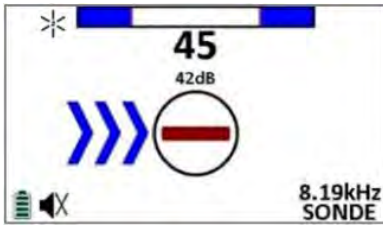

2. Use the Left/Right arrows to center the Receiver over the Sonde.

3. Move the Receiver Forward/Back to obtain the strongest signal to pinpoint and precisely Locate the Sonde.

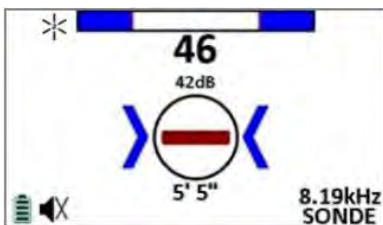

4. Depth indication is displayed to the center of the Sonde.

ATTENTION

Auto Depth will be displayed when the rotation is correct and the Left/Right arrows are centered. The depth is not correct until the strongest signal is found by moving the Receiver in the Forward/Back axis.

10.6.3 Null Points

Deep Sondes can be difficult to precisely locate with the above method. Follow these steps to use the signal Null Points in front and behind the Sonde to more accurately pinpoint the exact position.

The signal transmitted from a Sonde has two Null Points, one near each end of the sonde. A Null Point is a location where the signal transmitted from a Sonde is completely vertical. These points can be used to improve pinpointing accuracy and speed particularly for Deep Sonde Locating.

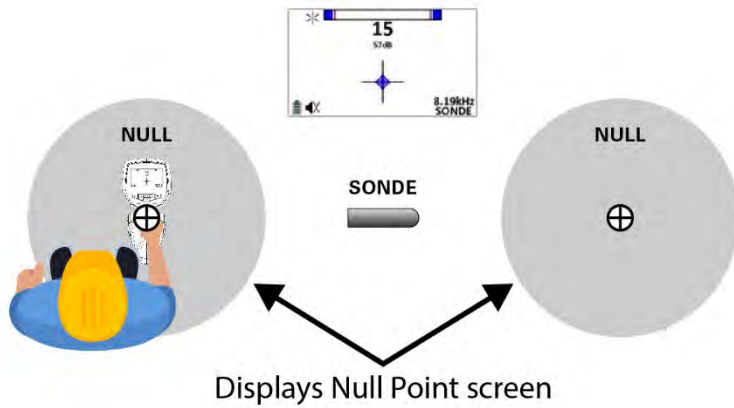

There are two different Sonde locating screens corresponding to the Null Point and Overhead areas. The Receiver automatically switches between these screens during Sonde locating. The Null Point screen will be displayed when close to a null point. The Overhead screen will be displayed when not close to a null point. The graphic below shows the areas where the Null Point screen is used.

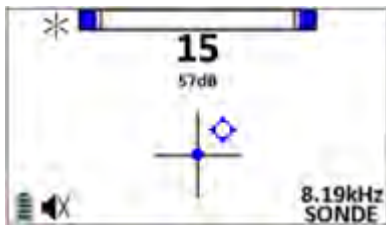

1. Keeping the Receiver vertical, move around the area until the Receiver displays the Null Point screen.

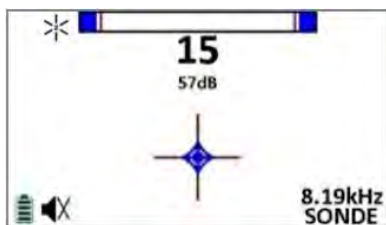

2. Move the Receiver to center the Null Point on the target graphic and mark the Null Point position on the ground.
3. Move in the direction of the Sonde past the Overhead Screen to find the second Null Point.

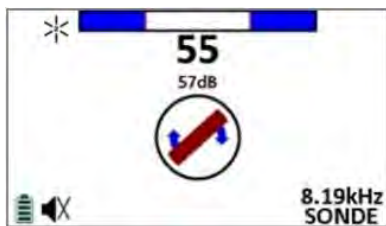

4. Move the Receiver to center the Null Point on the target graphic and mark the second Null Point position on the ground.
5. Move the Receiver to the point midway between the Null Points.
 6. Use the rotation arrows to correctly orient the Receiver.

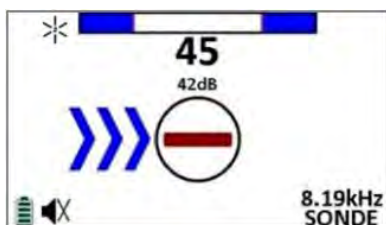

7. Use the Left/Right arrows to center the Receiver over the Sonde.
8. Move the Receiver Forward/Back to obtain the strongest signal to pinpoint and Locate the Sonde.

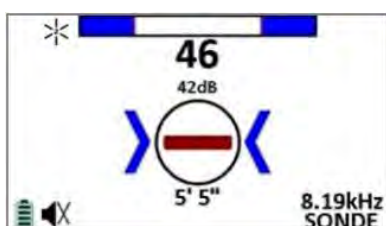

9. Depth indication is displayed to the center of the Sonde.
10. Depth can also be estimated at 0.7x distance between the NULL points.

11. Technical Data Table

11.1 Receiver Specifications

Dimensions	26.7in x 5.8in x 12.7in (679mm x 148mm x 324mm)	Frequency Range	50Hz - 200kHz
Weight	4.8lbs (2.2kg)	Max Automatic Depth³	19.7ft (6m)
Operating Temperature	-4°F to 122°F (-20° to 50°C)	Max Pushbutton Depth³	36ft (11m)
Storage Temperature	-40°F to 160°F (-40° to 70°C)	Accuracy (Locate)	+/- 5% of depth
Batteries	Lithium-ion battery pack, 35.5Wh 6x AA (LR6) with Alkaline battery pack Automatic battery type detection	Accuracy (Depth)³ - Line - Sonde - Passive	+/- 5% to 9.8ft (3m) +/- 5% to 9.8ft (3m) +/- 10% to 9.8ft (3m)
Battery Life	Lithium: 15 hours continuous (30 intermittent) Alkaline: 5 hours continuous (10 intermittent) 2 hours	Sensitivity:	1x10 ⁻¹⁵ Tesla (1uA @ 1m, 32.8kHz)
Charge Time			
Locate Modes	Single, Twin, Null Sweep (Omnidirectional) Twin Sweep (Omni Directional) (Omnidirectional)	Automatic overload protection	Up to 60dB
Display	High-Visibility Color Transflective Display, 4.3"		
Gain Control	Manual with One Touch	Frequency Analyzer	Scans area for noise Recommends the best frequencies
Active Locate Frequencies	Standard Frequencies: 256Hz, 263Hz, 440Hz, 512Hz, 560Hz, 577Hz, 640Hz, 815Hz, 870Hz, 940Hz, 1.02kHz, 1.17kHz, 3.14kHz, 4.1kHz, 8.01kHz, 8.19kHz, 9.82kHz, 12.1kHz, 16.3kHz, 22.5kHz, 29.4kHz, 32.8kHz, 44.5kHz, 66.1kHz, 88.8kHz, 99kHz, 132kHz, 200kHz	Passive Frequencies	Power - 50Hz, 150Hz, 450Hz for 50Hz grid - 60Hz, 180Hz, 540Hz for 60Hz grid Grouped Power: - Detects power frequencies and harmonics simultaneously Cathodic Protection (CP) - CP120 for 60Hz grid - CP100 for 50Hz grid Radio: 13kHz to 28kHz
Sonde Frequencies	4 Frequencies: 512Hz, 640Hz, 8.19kHz, 32.8kHz	Custom Frequencies	Available by request
Data Logging	4GB Internal Storage 16 million records	Wireless Connections	BLE 5.1
Environmental	IP65 ¹	Accessories	Ring Clamp

¹ IP65 Rating: The IP65 rating indicates a product is “dust tight” and protected against water jets from any direction. Whether used in harsh weather conditions or dusty settings, an IP65-rated device offers reliable protection, ensuring long-lasting performance and durability.

² In standby, a small amount of voltage and current are used to measure the impedance of the utility.

³ Depth accuracy based on a single undistorted signal source.

11.2 Transmitter Specifications

Dimensions	8.3in x 7.6in x 15in (210mm x 193mm x 381mm)	Frequency Range	256Hz - 200kHz
Weight	7.9lbs (3.6kg)	Max Power Output	10w (1w above 45kHz)
Operating Temperature	-4°F to 122°F (-20° to 50°C)	Max Current Output	1000mA (500mA above 45kHz)
Storage Temperature	-40°F to 160°F (-40° to 70°C)	Max Voltage Output	90Vrms
Environmental	IP65 ¹	Output Power Levels	4 levels + Standby ²
Batteries	Lithium-ion battery pack, 94.7Wh 8x D-Cell (LR20) with Alkaline Pack Automatic battery type detection	Active Locate Frequencies	Standard Frequencies: 256Hz, 263Hz, 440Hz, 512Hz, 560Hz, 577Hz, 640Hz, 815Hz, 870Hz, 940Hz, 1.02kHz, 1.17kHz, 3.14kHz, 4.1kHz, 8.01kHz, 8.19kHz, 9.82kHz, 12.1kHz, 16.3kHz, 22.5kHz, 29.4kHz, 32.8kHz, 44.5kHz, 66.1kHz, 88.8kHz, 99kHz, 132kHz, 200kHz
Battery Life	Lithium: 17 hours continuous (34 intermittent) Alkaline: 10 hours continuous (20 intermittent) 4 hours	Custom Frequencies	Available by request
Charge Time			
Display	High Contrast Graphical LCD	Induction Frequencies	3.14kHz and above
		Dual Output Ports	Connect any two accessories Select the active accessory with Mode key
		Accessories	Direct Connect Leads ⁴ Ring Clamp

11.3 System Specifications

Regulatory Compliance	FCC, CE.	Language Support	22 user-selectable languages:		
Data Transfer	USB-C 2.0	English	Dutch	Norwegian	Hungarian
PC based Setup	User configurable Product Firmware Updates with UM Setup	Spanish	Portuguese	Latvian	Romanian
		French	Russian	Lithuanian	Chinese
		German	Swedish	Czech	Korean
		Italian	Danish	Finnish	
		Polish	Estonian	Greek	

¹ IP65 Rating: The IP65 rating indicates a product is “dust tight” and protected against water jets from any direction. Whether used in harsh weather conditions or dusty settings, an IP65-rated device offers reliable protection, ensuring long-lasting performance and durability.

² In standby, a small amount of voltage and current are used to measure the impedance of the utility.

³ Depth accuracy based on a single undistorted signal source.

³ Insulation rated to 600V.

12. Safety Directions

The following instructions enable the person responsible for the product and the user to anticipate and avoid hazards of use.

The person responsible for the product must ensure all users understand these hazards, the precautions and follow them.

12.1 Intended Use

The products are intended to be used for the following applications:

- ❖ The UM 10W is intended for outdoor use as a Utility Locating Transmitter.
- ❖ The UM 10W is a DC battery operated device. The battery may only be charged using an approved UM6400-16 charger.
- ❖ The UM Dual is intended for detection and localizing of buried utilities: cables and metallic pipes.
- ❖ Transmitter signal applied to target utilities by connection, induction, or accessories.
- ❖ Indication of the depth of an underground utility or accessory.
- ❖ To be operated in accordance with instructions in this Operating Manual.
- ❖ Designed in accordance with applicable standards and regulations. Equipment may only be modified at authorized repair centers.
- ❖ May only be used with Underground Magnetics approved accessories.

12.2 Adverse Use

- ❖ Outside intended use and limits.
- ❖ Use of the product without instruction.
- ❖ After theft.
- ❖ Removal of hazard notices.
- ❖ Modification of the products.
- ❖ Use of the product with recognizable damages or defects.
- ❖ Opening the product using tools unless this is specifically permitted.
- ❖ Inadequate site safeguards.

CAUTION

Adverse use can lead to injury, damage, or malfunction.

Precautions: The person responsible must inform the user about specific hazards and how to counter them. The product should not be operated until the user has been instructed how to use and work with it.

12.3 Limits of Use

Suitable for use in an environment suited for permanent human habitation. Not suitable for hazardous atmosphere, aggressive or explosive environments.

CAUTION

Working in hazardous areas, with electrical equipment or electrical railways can lead to injury.

Precautions: The person responsible for the product should contact safety authorities and safety experts before working in hazardous environments or when near electrical equipment or similar situations.

12.4 Responsibilities

Underground Magnetics Inc, Johnston Iowa 50131, USA is responsible for supplying the product, including the operating manual and original accessories, in a completely safe condition.

The person responsible for the product has the following responsibilities:

- ❖ To understand the safety instructions on the product and the instructions in the operating manual.
- ❖ To ensure the user of the product uses it in accordance with the Operating instructions and is trained in its use.
- ❖ To be familiar with local regulations and safety codes relating to the user, 3rd party persons, environmental and property safety, and accident prevention.
- ❖ To inform Underground Magnetics Inc. if the product and application becomes unsafe.
- ❖ To ensure that national laws, regulations, and conditions for the operation of the product, including radio transmitters, are respected.

12.5 Hazards of Use

WARNING

Connecting to a live cable can result in an electrical shock and potentially lethal.

Precautions: Never connect the output cable directly to an electrically live cable. Only authorized personnel should make connections to pipes or cables. The Transmitter will display a warning when a High or Dangerous voltage is present.

When using the Clamp Accessory a hazardous signal may be present causing personal harm.

Precautions: Do not use electrical cables that have impaired or no insulation. Contact qualified people and follow all standards and requirements for disconnecting or grounding cables. Do not remove any safety bonding unless authorized.

Hazardous voltage may be present on plug of the Clamp Accessory when clipped over a live cable.

Precautions: Connect the Clamp to the Transmitter or Receiver before clamping around a live cable.

12.6 Worksite Safety

CAUTION

During dynamic use there is a danger of accidents if the user does not pay attention to the working environmental conditions, obstacles, traffic, or excavations.

Precautions: The person responsible for the product must ensure all users are fully aware of existing dangers. Observe working environment for environmental hazards from ground terrain, near traffic or other machinery in use.

Inadequate securing of the job site can lead to dangerous situations due to traffic, building sites and industrial installations.

Precautions: Follow company or federal regulations governing safety, accident prevention and road traffic management precautions. Ensure the job site is adequately secure.

Use of equipment is not intrinsically safe for use in areas where hazardous gases may be present.

Precautions: Do not use products in designated hazardous areas. Seek approval before use from authorized safety representative.

Working on or near electrically live utilities can result in electrical shock or equipment damage.

Precautions: Do not operate equipment unless properly qualified and familiar with its use. Do not exceed equipment recommended rating and instruction in use. Inspect equipment and cables for damage, do not use if faulty. Do not work on electrically live power utilities unless properly qualified. Use personal protective equipment (PPE) rated for the utility voltage and current.

12.7 Batteries and Environmental Safety

The batteries used by Underground Magnetics meet the required safety standards and include safety protection circuitry to prevent accidental damage in use.

Packaging of spare battery packs MUST include specified warning labels. Please contact Underground Magnetics Service Support or your Dealer for more details.

CAUTION

Warning Symbol Explanation (Battery)

Use only UM6400-16 Batteries in the UM 10w Transmitter

Charge only with UMB8-16 Battery charger

UMB8-16 Battery Changer input is 100VAC – 240VAC 50/60Hz, 1.5A Max

Use only UM3200-12 Batteries in the UM 10w Transmitter

Charge only with UMB3-12 Battery charger

UMB8-16 Battery Changer input is 100VAC – 240VAC 50/60Hz, 1.5A Max

ATTENTION

During shipping, transportation, or disposal of batteries it is possible that inappropriate mechanical influences may constitute a fire hazard.

Precautions: Remove the batteries before shipping. When transporting or shipping the product the person responsible for the product should ensure that the applicable national or international rules and regulations are observed. Before shipping or transportation contact your local passenger or freight transport company.

12.8 Equipment Safety

CAUTION

Cleaning Products whilst in use may damage or create a safety hazard.

Precautions: Turn off and isolate Product before cleaning. Do not immerse in liquid.

If the product is improperly disposed of the following can happen: Polymers may burn, Poisonous gases may be produced which may impair health, Batteries can explode causing poisoning, burning corrosion or environmental contamination.

Precautions: The product must not be disposed of with household waste. Always dispose of the product in accordance with Federal, company or local regulations. Always prevent access to the product by unauthorized personnel.

High mechanical stress or temperatures or immersion in fluids can cause chemical leakage, fire, or explosions of the batteries.

Precautions: Protect the batteries from high mechanical influences and high ambient temperatures. Do not drop the batteries into fluids.

Unauthorized service and repair may result in a hazardous product.

Precautions: Only Underground Magnetics authorized service workshops are entitled to repair these products

ATTENTION

Absence of a signal does not guarantee the non-existence of a utility.

Nonmetallic utilities will not be detected without the use of an accessory or buried tracer wire.

Some utilities may be present without a detectable signal.

A potentially hazardous signal can be present at the Transmitter output, on the accessory connector or an electrically live utility. Exercise caution when making Transmitter connections.

Always connect to the utility before powering the Transmitter ON.

Use only the supplied UM lithium battery chargers for charging UM lithium batteries.

Do not attempt to disassemble the lithium battery packs.

13. Appendix 1 Best Practice Training Instruction

This Instruction has proven effective for new hire Technician training programs and may be directly useful for Company Locator Training Services teams.

Step One: Perform a “FA” (Frequency Analysis) along the path of the intended are to be surveyed/located. Ideally choose the lowest frequency available with a pass (Green check mark). Note, lowest frequency is not a guarantee the signal will successfully carry the length of the pipe/cable. Users may have to adjust to a higher frequency. Important, ensure the Transmitter is not turned on while a “FA” is being done. The Frequency Analysis stated purpose is to scan the given locate area and determine which if any available frequencies are subject to local interference.

Step Two: Direct Connection Method (Preferred). Take the **Black** Direct Connection Lead and connect it to the ground stake provided. Connect the **Red Direct Connection Lead** to the pipe/cable. Turn on the Transmitter.

CAUTION

If the Transmitter displays a small lightning bolt symbol in the top left corner of the LCD be aware the Line connected has a high level of voltage (>110V) that could be harmful to the user.

Precautions: Consult your employers Safety Compliance Team.

WARNING

If the Transmitter displays a large lightning bolt symbol in the center of the LCD, be aware the line connected to has a dangerously high voltage (>250V) that could be life threatening to the user.

Precautions: Do not touch any parts of the Locator equipment, move away to a safe distance, and consult your Employer’s Safety Compliance Team.

Step Three: Select the lowest Frequency recommended by “FA.”

Step Four: With the Transmitter ON. Note the line Impedance (ohms). Rule of thumb is the higher the Line (pipe/cable) Impedance, the lower the Current Output. Guideline suggestion, a single line (pipe/cable) should exhibit a low impedance providing the line is grounded at both ends, user is encouraged to seek parameters from his/her employer. In the example of a wire or cable, again single line, a reasonable threshold might be >5,000 ohms exercise caution as the line might not be grounded at the far end. If that is the case, use the supplied second ground stake and wire spool to ground the far end. Next, return the Transmitter and verify the line impedance as shown on the Transmitter LCD. If the impedance is less, you have ensured the best possible outcome. Note, once the Transmitter is turned on , it defaults to a “Standby Mode” user is required to increase the output level off the Standby Mode.” To improve the signal output (current/mA), increase or max out the power output to levels 1-4.

Step Five: SWEEP (360 degrees) Either in the “Twin Peak Mode”, or the “SWEEP Mode” with the Receiver on, selected Frequency matching the Transmitter, initial Gain Setting (90dB-100dB range) circle the Utility Connection Point. All Peak (maximum) responses should be dotted with paint or marked with a Flag. Using Prints/As-builts, Landmarks, Passive Modes (Power & Radio), Current Measurement, Depth, Peak and Null Responses. Chose the most likely Line (pipe/cable) path that matches up to the Utility you are trying to trace out.

Step Six: Verify, Peak and Null Responses. If the Peak and Null (optional left/right arrows, null) do not match up that would be an indication of Electromagnetic Field Distortion. Left/right arrows indicate a null signal. Centered arrows indicate a nulled-out signal. This prevents the user from changing between peak and null modes unnecessarily. The greater the separation the more likely the locate position has been compromised. Verify Utility identity by Employers Best Practice. Providing the Peak and Null do match up follow and “dot out” the line to the end point (verify). Most practices require the user to revise direction and “mark out” the line back towards the Transmitter connection point.

ATTENTION

Users are strongly encouraged to follow Employer’s Best Practice Procedures and Safety Compliance.



UMAGHDD.COM | 515.505.0960